



EQUIPMENT & SUPPLIES





EQUIPMENT

PPG has everything you need to complete your paint project in a professional way. From the full line of both Graco and Titan spray equipment for all coating types and texture materials, to pressure washers, generators, heaters and much more!

Visit PPG Paints, Your Equipment Destination for everything you need to get the job done.

TABLE OF CONTENTS

▶ HANDHELDS	7
▶ SMALL & MID SIZED ELECTRIC	8 - 9
▶ LARGE ELECTRIC	10 - 11
▶ GAS	12 - 15
▶ FINE FINISH & HVLP	16 - 17
▶ TEXTURE	18 - 21
▶ ROOFING	22 - 24
▶ STRIPING	25 - 29
▶ DISINFECTANT EQUIPMENT	30 - 31
▶ SPRAY GUNS, TIPS & ACCESSORIES	34 - 45
▶ PRESSURE WASHERS – COLD WATER	46 - 52
▶ PRESSURE WASHERS – HOT WATER	53 - 55
▶ PRESSURE WASHER ACCESSORIES	56 - 58
▶ GENERATORS	59 - 61
▶ AIR COMPRESSORS	62 - 64
▶ HEATERS	65 - 69
▶ OTHER EQUIPMENT	70 - 71



PROVEN CHOICE OF PROFESSIONAL CONTRACTORS

GRACO-ONLY INNOVATIONS

MAXIMUM PRODUCTIVITY

FINISH MORE JOBS



BLUELINK™
Sprayer Management System
Measure productivity from anywhere with a breakthrough mobile app



QUIKREEL™
Easy Hose Management
Fast and easy setup—deploy and rewind up to 300 ft hose in seconds



FASTFLUSH™
More Spraying and Less Cleaning
Clean the pump 4X faster with 1/2 the amount of waste water

LONGEST LIFE

SPRAY LONGER WITH LOWEST COST OF OWNERSHIP



**ENDURANCE VORTEX
MAXLIFE™ EXTREME**
Longest Lasting Pumps Ever Built
Up to 6X more gallons sprayed between repacks



PROCONNECT™ 2
Maximize Uptime on the Job
Eliminate downtime—swap your pump in minutes with no tools

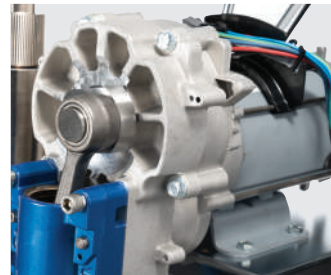

**MAXPOWER™ MOTOR AND
ADVANTAGE DRIVE™**
Longest Lasting Motor and Drive
Maintenance-free performance delivered with lifetime warranty

PROVEN RESULTS

INDUSTRY'S BEST SPRAY FINISH



SMARTCONTROL™
Precision Spraying Control
Precision spray control without pressure fluctuations



EASY OUT™
Large, Durable Filtration
Crushproof Inlet Strainer—withstands harsh impacts to maintain filtering and flow



For more information
visit graco.com



INNOVATIONS THAT TAKE PRODUCTIVITY TO A WHOLE NEW LEVEL.

Titan supports your business with a relentless commitment to building sprayers and tools that lead to better work, improved ROI and increased profits.

INDUSTRY'S BEST AND LONGEST WARRANTY.

We have the utmost confidence in our craftsmanship and proudly stand behind every product we make.

**WEAR
GUARD**

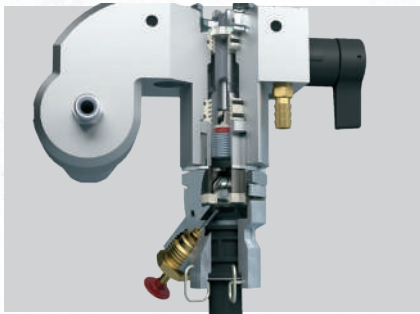

QUAD+ PACKINGS™ / PERMALIFE™ CYLINDER

Self-adjusting and self-compensating packaging and no wearable cylinder deliver the longest life and lowest repair costs in the industry.

Available on Impact® Series.

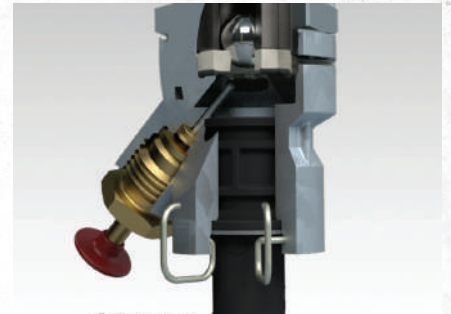

SUREFLO™ PUSHER VALVE

Primes the first time, every time. Unstick the lower ball valve with a push of a button. No need for a hammer.

Available on Impact® 440, 540 & 640, Elite™ 3000 & 3500.



FIELD SERVICEABLE

Whether you are changing the entire fluid section, the inlet or outlet valves or the packings, it fast and easy with Titan's fluid pump designs.

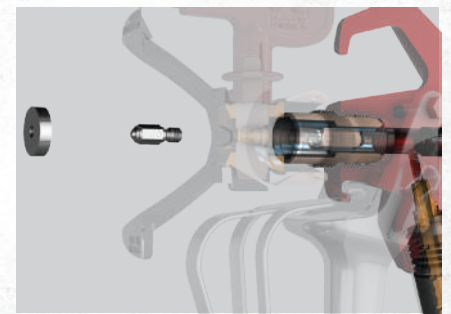

INFINITY PACKING® SYSTEM

Get two times the life by reversing the seat and changing the ball. The spring and needle assembly is isolated from the fluid path increasing flow and reducing wear.

Available on RX-Pro & RX-Apex.



PERMASTROKE™ TECHNOLOGY

Never worry about replacing your piston, packings, cylinder or clutch ever again. Featuring a lifetime warranty on the fluid pump.



CAPSPRAY™ SERIES

Lightweight and durable design, Capspray makes jobsite life easier. Capspray 115 is powered by the industry's most robust 6-stage turbine.



SPRAY EQUIPMENT

PPG carries a full assortment of Spray Equipment to get your job done fast, with the best quality finish.

From handholds to roof rigs, and everything in between, PPG has a professional-grade sprayer for you!

Gallons Per Week	Occasional Use / Touch Up			
HANDHELD ELECTRIC	 	 	 	 
	Product Official Name	FlexSpray Handheld	Ultra® Airless Handheld Corded	Ultra Airless Handheld Cordless
Max Tip Size (in.)	FlexFinish Nozzle	0.016	0.016	0.016
Max psi		2,000	2,000	2,000
Power Source	Corded	Corded	Two 20V DeWALT® Batteries	Two 20V DeWALT Batteries
Motor Type/Size		1/4 HP Brushed AC	1/4 HP Brushed AC	1/4 HP Brushless DC
Weight (lbs.)		4.6	5.25	5.25
Tips Included	FlexFinish Nozzle	FFLP514	FFLP514	FFLP514
Flammable Solvent Capable	Yes	No	No	Yes
Tip Support	Flex/Fine Finish Front End	RAC® X™ FFLP (.008-.016 only)	RAC X FFLP (.008-.016 only)	RAC X FFLP (.008-.016 only)
PPG # Vendor #	TTI22426/EA 524093	GRA38540/EA 17M359	GRA38539/EA 17M363	GRA39025/EA 17M367

SMALL & MID SIZED ELECTRIC SPRAYERS

Gallons Per Week	0 - 50 Gallons				
					
					
Product Official Name	Ultra® 390 PC	Ultra 390 PC Cordless	Impact 410	Ultra® 395 PC	Impact 440
Max GPM	0.47	0.47	0.47	0.54	0.54
Max Tip Size (in.)	0.021	0.021	0.021	0.023	0.023
Max PSI	3,300	3,300	3,100	3,300	3,300
Motor Size / Type	5/8 HP Brushed DC	Two 60V DeWALT FlexVolt Batteries Brushless DC	3/4 HP DCX	7/8 HP TEFC Brushed DC	7/8 HP DCX
Weight (lbs.)	30	26	34	42	37
Tip Included	RAC® X™ LTX515	RAC X LP515	TR'517	RAC X LTX517	TR'517
Gun Included	FTx™	FTx	RX-80	Contractor® PC	RX-80
Hose Included	1/4" x 50'	1/4" x 50'	1/4" x 50'	1/4" x 50'	1/4" x 50'
Gun Support	1	1	1	1	1
Stand	GRA69513/EA 17C310	GRA18081/EA 25T804	TTI27610/EA 532052	GRAX1856/EA 17E844	TTI17967/EA 805-000E
Low Frame				GRAX1855/EA 17E845	WST19273/EA 805-019A
High Frame	GRA69972/EA 17C313	GRA18098/EA 25T805	TTI27611/EA 532053	GRAX1857/EA 17E846	TTI18130/EA 805-016A

50 - 75 Gallons

75 - 100 Gallons

50 - 75 Gallons		75 - 100 Gallons			
					
					
Ultra Max II 490 PC Pro	Ultra Max II 495 PC Pro	Impact 540	Elite 3000	Impact 640	Ultra Max II 595 PC Pro
0.54	0.6	0.6	0.6	0.7	0.7
0.023	0.025	0.024	0.025	0.027	0.027
3,300	3,300	3,300	3,300	3,300	3,300
1.0 HP Brushless DC	1.2 HP Brushless DC	1.2 HP DuraLife Bushless HE	1.2 HP DCX	1.55 HP DuraLife Brushless HE	1.6 HP Brushless DC
34	34	38	102	65	72
RAC X LTX517	RAC X LTX517	TR'517	TR'517	TR'517	RAC X LTX517
Contractor PC	Contractor PC	RX-Pro	RX-Pro	RX-Pro	Contractor PC
1/4" x 50'	1/4" x 50'	1/4" x 50'	1/4 x 50'	1/4" x 50'	1/4" x 50'
1	1	1	1	1	1
GRAX1863/EA 17E852	GRAX1867/EA 17E855	TTI18127/EA 805-001		TTI18000/EA 805-002	
GRAX1865/EA 17E853	GRAX1868/EA 17E856	TTI18001/EA 805-003	TTI27665/EA* 2402333 Convertible High and Low Frame in one!	TTI17998/EA 805-005	GRAX1870/EA 17E858
GRAX1866/EA 17E854	GRAX1869/EA 17E857	TTI17999/EA 805-006		TTI17997/EA 805-004	GRAX1871/EA 17E859

LARGE ELECTRIC SPRAYERS

Gallons Per Week

100 - 150 Gallons

LARGE ELECTRIC SPRAYERS



Product Official Name	Ultra Max II 650 PC Pro	Impact 740	Ultra Max II 695	Impact 840
Max GPM	0.8	0.8	0.95	1
Max Tip Size (in.)	0.029	0.029	0.031	0.032
Max PSI	3,300	3,300	3,300	3,300
Motor Size / Type	1.8 HP Brushless DC	2.0 HP DuraLife Brushless HE	2.0 HP MaxPower Brushless DC	2.3 HP DuraLife Brushless HE
Weight (lbs.)	77	83	93	83
Tip Included	RAC X LTX517	TR ¹ 517	RAC X LTX517	TR ¹ 517
Gun Included	Contractor PC	RX-Pro	Contractor PC	RX-Pro
Hose Included	1/4" x 50'	1/4" x 50'	1/4" x 50'	1/4" x 50'
Gun Supported	2 (.019 Tip)	2 (.017 Tip)	2 (.023 Tip)	2 (.021 Tip)
Low Frame Standard	GRA95702/EA 19Y129	TTI18131/EA 805-008	GRAX1735/EA 17E572	TTI18132/EA 805-010
High Frame - Standard	GRA95699/EA 19Y128	TTI18128/EA 805-007	GRAX1974/EA 17E574	TTI18129/EA 805-009
High Frame - ProContractor			GRAX1736/EA 17E577	
High Frame - IronMan				



150 - 200 Gallons





200 - 500 Gallons

150 - 200 Gallons		200 - 500 Gallons			
					
Ultra Max II 795	Impact 1040	Ultra Max II 1095	Impact 1140	Ultra Max II 1595	Impact 1640
1.1	1.15	1.2	1.2	1.35	1.5
0.033	0.033	0.035	0.034	0.039	0.037
3,300	3,300	3,300	3,300	3,300	3,300
2.0 HP MaxPower Brushless DC	2.5 HP DuraLife Brushless HE	2.2 HP MaxPower Brushless DC	2.6 HP DuraLife Brushless HE	2.2 HP MaxPower Brushless DC	3.6 HP Brushless DC
98	98	120	103	125	98
RAC X LTX517	TR ¹ 517	RAC X LTX517	TR ¹ 517	RAC X LTX517	TR ¹ 517
Contractor PC	RX-Pro	Contractor PC	RX-Pro	Contractor PC	RX-Apex
1/4" x 50'	1/4" x 50'	1/4" x 50'	1/4" x 50'	1/4" x 50'	3/8" x 50'
3 (.019 Tip)	2 (.022 Tip)	3 (.021 Tip)	2 (.023 Tip)	3 (.023 Tip)	2 (.025 Tip)
			TTI18134/EA 805-012		
GRAX1966/EA 17E579	TTI22496/EA 552600	GRAX1775/EA 17E583	TTI18133/EA 805-011	GRAX1795/EA 17E589	TTI29415/EA 2404441
GRAX1737/EA 17E582		GRAX1766/EA 17E585		GRAX1786/EA 17E596	
		GRAX1777/EA 17E586		GRAX1725/EA 17E594	

GAS MECHANICAL SPRAYERS

Gallons Per Week	50 - 100 Gallons	75-100 Gallons	500+	
				
Product Official Name	GMAX® 3400	Elite 3500	GMAX II 3900	GMAX II 5900
Max GPM (lpm)	0.75	0.75	1.25	1.6
Max Tip Size (in.)	0.027	0.027	0.036	0.043
Max psi (bar)	3,300	3,300	3,300	3,300
Motor Size / Type	Honda® 120 cc (4.0 HP)	Honda GX 120 cc	Honda 120 cc (4.0 HP)	Honda 200 cc (6.5 HP)
Weight (lbs.)	89	95	109	139
Tip Included	RAC X 517	TR'517	RAC X 517	RAC X 517
Gun Included	Contractor PC	RX-Pro	Contractor PC	Contractor PC
Hose Included	1/4" x 50'	1/4" x 50'	1/4" x 50'	1/4" x 50'
Gun Support	1 (.027) Tip	1 (.027) Tip	2 (.023) Tip	3 (.023) Tip
Low Frame		TTI24996/EA 537013	GRAX1717/EA 17E826	GRAX1703/EA 17E829
High Frame - Standard	GRAX1699/EA 17E825	TTI26533/EA 537012	GRAX1701/EA 17E827	GRAX1705/EA 17E831
High Frame - ProContractor			GRAX1702/EA 17E828	GRAX1706/EA 17E832
High Frame - IronMan				GRAX1707/EA 17E833
Convertible				GRAX1704/EA 17E830





Gallons
 
GMAX II 7900
2.2
0.048
3,300
Honda 200 cc (6.5 HP)
146
RAC X 517
Contractor PC
3/8" x 50' BlueMax II & 1/4" x 3' Whip
4 (.023 Tip)
GRAX1708/EA 17E834
GRAX1710/EA 17E836
GRAX1711/EA 17E837
GRAX1712/EA 17E838

Gallons Per Week	200 - 500 Gallons	
GAS HYDRAULIC SPRAYERS	 	 
	GH™ 130 Convertible	PowrTwin 4900 Plus Gas
Product Official Name	GH™ 130 Convertible	PowrTwin 4900 Plus Gas
Max GPM	1.30 (gas motor)	1.50
Max Tip Size (in.)	0.037	0.038
Max PSI	3,300	3,300
Motor Size / Type	Honda 120 cc (4.0 HP)	Honda GX 160 cc
Weight (lbs.)	155	132
Tip Included	RAC X 517 & WR1231	TR'517
Gun Included	Contractor	RX-Pro
Hose Included	1/4" x 50'	1/4" x 50'
Guns Supported	2 (.023 Tip) with gas motor	3 (.028 Tip)
*Based on Gas Motor	GRA69974/EA 24W923 (Standard - Gas)	WST20080/EA 290012 (Standard - Gas)
	GRA69975/EA 24W924 (Standard - Electric)	

GAS HYDRAULIC SPRAYERS continued















Gallons Per Week	200-500 Gallons			
				
Product Official Name	PowrBeast 4700	PowrBeast 7700	GH 200 Convertible	PowrTwin 6900 Plus Gas
Max GPM	1.60	2.00	2.15	2.25
Max Tip Size (in.)	0.041	0.047	0.047	0.050
Max PSI	3,000	3,300	3,300	3,300
Motor Size / Type	Honda GX 160 cc	Honda GX 200 cc	Honda 160 cc (5.5 HP)	Honda GX 160 cc
Weight (lbs.)	173	179	160	139
Tip Included	TR'517	TR'517	RAC X 517 & WR1231	TR'517
Gun Included	RX-Pro	RX-Pro	Contractor	S-3
Hose Included	1/4" x 50'	1/4" x 50'	1/4" x 50"	1/4" x 50'
Guns Supported (w/ gas motor)	4 (.019 Tip)	4 (.023 Tip)	4 (.023 Tip)	4 (.023 Tip)
*Based on Gas Motor	TTI24318/EA 537001 (Standard - Gas)	TTI24643/EA 537005 (Standard - Gas)	GRA69976/EA 24W925 (Standard - Gas)	WST20081/EA 290013 (Standard - Gas)
			GRA69977/EA 24W926 (Standard - Electric)	WST20880/EA 290028 (Standard - Electric)
			GRA69978/EA 24W927 (ProContractor - Gas)	WST20185/EA 290021 (Direct Imersion - Gas)
			GRA69980/EA 24W928 (ProContractor - Electric)	WST20881/EA 290029 (Direct Imersion - Electric)

500+ Gallons

 	 	 	 	 
GH 230 Convertible	PowrTwin 8900 Plus Gas	PowrBeast 9700	GH 300	PowrTwin 12000 Plus Gas
2.35	2.50	3.00	3.00	3.15
0.053	0.054	0.055	0.057	0.058
3,300	3,300	3,000	3,300	3,600
Honda 200 cc (6.5 HP)	Honda GX 200 cc	Honda GX 270 cc	Honda 270 cc (9.0 HP)	Honda GX 270 cc
168	155	199	195	183
RAC X 517 & WR1231	TR'517	TR'517	RAC X 517 & WR1231	TR'517
Silver Plus	RX-Apex	RX-Pro	Silver Plus	RX-Apex
3/8" x 50" & 1/4" x 3' Whip	1/4" x 50"	1/4" x 50'	3/8" x 50" & 1/4" x 3' Whip	1/4" x 50"
5 (.024 Tip)	5 (.024 Tip)	5 (.023 Tip)	5 (.025 Tip)	6 (.024 Tip)
GRA69981/EA 24W929 (Standard - Gas)	WST20086/EA 290018 (Standard - Gas)	TTI24645/EA 537007 (Standard - Gas)	GRA69987/EA 24W935 (Standard - Gas)	WST20084/EA 290016 (Standard - Gas)
GRA69982/EA 24W930 (Standard - Electric)	WST20879/EA 290027 (Standard - Electric)		GRA69990/EA 24W936 (ProContractor - Gas)	TTI20186/EA 290023 (Direct Imersion - Gas)
GRA69983/EA 24W931 (Standard - CSA Electric)				
GRA69984/EA 24W932 (ProContractor - Gas)				
GRA69985/EA 24W933 (ProContractor - Electric)				
GRA69986/EA 24W934 (ProContractor - CSA Electric)				

FINE FINISH & HVLP SPRAYERS

					
					
Product Official Name	Air Coat	FinisHPro™ GX19 Airless	FinisHPro II 395 PC Air-Assisted Airless	MultiFinish 440	FinisHPro II 595 PC Pro Air-Assisted Airless
Max GPM	0.35	0.38	0.47	0.54	0.7
Max Tip Size (in.)	0.017	0.019	0.021	0.023	0.027
Max psi (bar)	2,800	3,300	3,300	3,300	3,300
Air Compressor Size	1/2 HP TEFC			7/8 HP PMDC	
Weight (lbs.)	56	27	107	90	108
Tip/Needle Included	Brilliant 9/20	FFLP210	FFLP210, LTX517, AAM309 Flat Tip	TR'415	FFLP210, LTX517, AAM309 Flat Tip
Gun Included	GM 3600	FTx	G-40	GM 3600	Contractor PC & G-40
PPG # Vendor #	WST16260/EA 0508074A (Standard)	GRA31489/EA 17F924 (Standard)	GRA00006/EA 17C417 (Standard)	TT119355/EA 524029 (Standard)	GRAX2045/EA 17E908 (Standard)

 	 	 	 	 	 	 
FinisHPro HVLP 7.0	Capspray 75	FinisHPro HVLP 9.0	Capspray 95	FinisHPro HVLP 9.5	Capspray 105	Capspray 115
7.0	7.5	9.0	9.5	9.5	10.5	11.5
3 - Stage	3-Stage	4 - Stage	4-Stage	5 - Stage	5-Stage	6-Stage, 2-Speed
18	20.5	19	21	26	22	23
#3 Quik Release Needle - Standard	#3 Needle	#3 Quik Release Needle - Standard	#3 Needle	#3 Quik Release, #4 Quik Release & #5 Quik Release Needle - ProContractor	#3 & #4 Needle	#3, #4, #5 Needle
#3 Quik Release Needle - ProContractor		#3 Quik Release & #4 Quik Release Needle - ProContractor		#3 Quik Release, #4 Quik Release & #5 Quik Release - ProComp Series		
EDGE® II - Standard	Maxum II	EDGE II - Standard	Maxum II	EDGE II Plus - ProContractor	Maxum II	Maxum II
EDGE II Plus - ProContractor		EDGE II Plus - ProContractor		EDGE II Plus & 2 Qt. Remote Cup - ProComp	Maxum Elite	Maxum Elite
GRA39046/EA 17N263 (Standard)	TTI19347/EA 524031 (Standard)	GRA39056/EA 17N264 (Standard)	TTI19348/EA 524032 (Standard)	GRA39431/EA 17N267 (ProContractor)	TTI22474/EA 524098 (Maximum II Gun)	TTI22473/EA 524099 (Maximum II Gun)
GRA39057/EA 17N265 (ProContractor)		GRA39058/EA 17N266 (ProContractor)		GRA39059/EA 17N269 (ProComp)	TTI19349/EA 524033 (Maximum Elite Gun)	TTI19350/EA 524034 (Maximum Elite Gun)

TEXTURE SPRAYERS

				
				
Product Official Name	MARK® IV HD 3-IN-1	Impact 1040 T	MARK V HD 3-IN-1	MARK X HD 240 V 3-IN-1
Max GPM	1.1	1.15	1.35	2.1
Max Tip Size (in.)	0.033	0.033	0.039	0.045
Max psi	3,300	3,300	3,300	3,300
Compressor Air Output				
Power Source	Electric	Electric	Electric	Electric
Motor Size / Type	MaxPower 2.2 HP Brushless DC	2.5 HP DuraLife Brushless HE Motor	MaxPower 2.8 HP Brushless DC	MaxPower 4.0 HP Brushless DC
Weight (lbs.)	108	98	135	142
Tip Included	RAC X LTX 425	TR'517	RAC X LTX 425	RAC X LTX531 and LTX541
Gun Included	Flex Plus	RX-Apex with Splatter Nozzle	HD Blue Texture	Inline HD Blue Texture
Hose Included	3/8" x 50'	3/8" x 50'	3/8" x 50'	1/2" x 50'
Hopper Included (gallon/liter)				
Gun Support	1	2 (.022 Tip)	1	1
PPG # Vendor #	GRAX1745/EA 17E603 (Standard)	TTI29404/EA 2405360 (Standard)	GRAX1796/EA 17E605 (Standard)	GRAX1755/EA 17E608 (Standard)
	GRAX1746/EA 17E604 (ProContractor)		GRAX1787/EA 17E606 (ProContractor)	GRAX1767/EA 17E609 (ProContractor)
			GRAX1726/EA 17E607 (IronMan)	







					
					
GMAX II 5900 HD	GMAX II 7900 HD	DutyMax™ GH 230 HD Convertible	DutyMax GH 300 HD	TexSpray® RTX™ 1400SI	TexSpray RTX 2000PI
1.6	2.2	2.35	3	1.4	2
0.043	0.048	0.053 (with gas motor)	0.057 (with gas motor)		
3,300	3,300	3,300	3,300	70	70
				6.1 cfm at 20 psi	6.1 cfm at 20 psi
Gas	Gas	Gas and Electric	Gas	Electric	Electric
Honda 200 cc (6.5 HP)	Honda 200 cc (6.5 HP)	Honda 200 cc (6.5 HP)	Honda 270 cc (9.0 HP)	1.7 HP	1.7 HP
147	159	203	218	63	70
RAC X LTX427 and LTX531	RAC X LTX427 and LTX531	RAC X LTX427 and LTX531	RAC X LTX643 and WR1239	Various Round Nozzles	Various Round Nozzles
HD Blue Texture	HD Blue Texture	Inline HD Texture	Inline HD Texture	Lightweight Air Spray Trigger	HD Air Spray Trigger
3/8" x 50'	3/8" x 50'	1/2" x 50' & 3/8" x 12' Whip	1/2" x 50' & 3/8" x 12' Whip	3/4" x 25'	1" x 25'
				10	13
1	1	1	1		
GRAX1713/EA 17E839 (Standard)	GRAX1715/EA 17E841 (Standard)	GRA69993/EA 24W943 (Standard-gas only)	GRA70004/EA 24W967 (Standard)	GRA32069/EA 17H572 (Standard)	GRA32070/EA 17H573 (Standard)
GRAX1714/EA 17E840 (ProContractor)	GRAX1716/EA 17E842 (ProContractor)	GRA69999/EA 24W962 (ProContractor-gas only)	GRA70005/EA 24W968 (ProContractor)		
GRAX1703/EA 17E829 (Lo-Boy)	GRAX1700/EA 17E843 (IronMan)				

TEXTURE SPRAYERS *continued*

				
				
Product Official Name	TexSpray RTX 2500PI	TexSpray RTX 5000PI	TexSpray RTX 5000PX	TexSpray RTX 5500PX 240 V
Max GPM	2.5	5	5	5.5
Max Tip Size (in.)				
Max psi (bar)	100	100	100	100
Compressor Air Output	6.1 cfm at 20 psi	8.6 cfm at 20 psi	8.6 cfm at 20 psi	9.1 cfm at 20 psi
Power Source	Electric	Electric	Electric	Electric
Motor Size / Type	1.7 HP	2.0 HP	2.0 HP	2.0 HP
Weight (lbs.)	72	159	163	163
Tip Included	Various Round Nozzles WideTex™ Adapters with XL W Tips	Various Round Nozzles WideTex™ Adapters with XL W Tips	Various Round Nozzles WideTex™ Adapters with XL W Tips	Various Round Nozzles WideTex™ Adapters with XL W Tips
Gun Included	HD Air Spray Trigger	HD Air Spray Trigger	HD Air Spray Trigger	HD Air Spray Trigger
Hose Included	1" x 25'	1" x 25'	1¼" x 25' HD	1¼" x 25' HD
Hopper Included (gallon/liter)	15	15	15	15
Gun Support				
PPG #	GRAX9485/EA	GRA32072/EA	GRAX32076/EA	GRA32078/EA
Vendor #	17U219 (Standard)	17H575 (Standard)	17H579 (Standard)	17H581 (Standard)

					
TexSpray GTX™ 2000EX	TexSpray FastFinish™	10:1 President (Carbon Steel Complete)	TexSpray HTX™ 2030	TexSpray T-MAX™ 6912 Airless	TexSpray T-MAX 6912 Air-Assisted Airless
4		3	3	3.2	3.2
120		1,000	1,000	1,000	1,000
User Supplied Air (minimum 12cfm at 100psi)	9.0 cfm at 40 psi	User Supplied Air (minimum 80 cfm at 90psi)		Compressor required for some textured finishes (minimum 20 SCFM)	Compressor required for some textured finishes (minimum 20 SCFM)
Gas	Electric		Gas	Electric	Electric
	2.0 HP	Air Motor	Honda 200 cc (6.5 HP)	2.0 HP Brushless DC	2.0 HP Brushless DC
95	Air Compressor: 68 FastFinish Gun: 4.8 G-TEX Gun: 4.1	43	155		
Various Round Nozzles	Various Round Nozzles WideTex™ Adapters with XL W Tips	6 mm nozzle	Various Nozzles, Fine Finish Kit & RAC X LTX643	RAC X LTX651	Various Round Nozzles WideTex™ Adapters with XL W Tips
HD Air Spray Trigger	G-TEX™	HD Air Spray	FreeFlow™ Inline Gun	HD Inline Lance	STX Air-Assist Texture Trigger
1" x 25'	3/8" x 50'	3/8" x 25' & 3/4" x 25' Air, 3/4" x 25' Fluid	3/4" x 50' & 3/8" x 50'	1" x 50' Material 3/4" x 10' Whip	1" x 50' Material 3/4" x 10' Whip
17	1.5			25	25
			1	1	1
GRA45518/EA 257030 (Standard)	GRAX9548/EA 25D494 (Standard)	GRA20407/EA 225886 (Complete)	GRA55272/EA 258740 (Complete)	17X989 (Standard)	17Z283 (Standard)
	GRAX9546/EA 25D492 (Pro Texture)		GRA55279/EA 258741 (Complete +)		

ROOFING SPRAYERS

	 	 	 	 
Product Official Name	GMAX II 7900 IronMan Roof Rig	Hydra Pro IV	Hydra M 2000	DutyMax GH 675DI
Max GPM	2.2	2.5	6	1.5
Max Tip Size (in.)	0.048	0.050"	0.075"	0.041
Max psi	3,300	3,300	2000	6,750
Motor Size / Type	Honda 200 cc (6.5 HP)	Honda GX 390 cc	Honda GX 390 cc	Honda 270 cc (9.0 HP)
Weight (lbs.)	157	350	385	207
Tip Included	RAC X LTX427 & LTX635			RAC XHD523, 527, 531
Gun Included	Heavy-Duty Blue			XTR-7 HF High Flow
Hose Included	3/8" x 50' BlueMax II			1/2" x 50' Xtreme Duty
Gun Support	1	5 (.021 Tip)	5 (.053 Tip)	1
PPG # Vendor #	GRAX1709/EA 17E835 (Complete)	TTI09794/EA 433-820 (Filter Model)	TTI0379/EA 433-860 (1" Outlet Model")	GRAX9539/EA 25D223 (Complete)
				GRAX9538/EA 25D225 (Big 150)
				GRAX0266/EA 25D226 (Big 150 - 25 gl Hopper)

 	 	 	 	  <div style="position: absolute; top: 10px; right: 10px; border: 2px solid red; border-radius: 50%; padding: 5px; color: red; font-weight: bold;">For Silicone!</div>
Hydra M 4000	GH 733	GH 833	GH 933	GH 933ES Hi-Flow
3.3	4	4	2.5	2.5
0.060"	0.065	0.065	0.053	0.053
4,000	4,000	4,000	7,250	7,250
Honda GX 390 cc	Honda 390 cc (13.0 HP)	Honda 390 cc (13.0 HP)	Honda 390 cc (13.0 HP)	Honda 390 cc (13.0 HP)
370	434	360	438	438
		RAC X LTX517 & LTX655	RAC XHD519	RAC XHD429
		Silver Plus	XTR-7 Airless XTR704	XHF Gun
		3/8" x 50' BlueMax II	3/8" x 50' Xtreme Duty	3/8" x 50' & 1/4" x 6' Xtreme Duty
5 (.025 Tip)	1	1	1	
TTI08731/EA 433-801 (Filter)	GRA38982/EA 16U279 (Bare - Electric Start)	GRA10580/EA 249318 (Bare)	GRA38985/EA 16U281 (Bare)	GRA68594/EA 17B484 (Bare)
TTI10404/EA 433-800 (3/4" Outlet)	GRA47160/EA 16U778 (Big 150)	GRA38991/EA 16U287 (Bare - Electric Start)	GRA38987/EA 16U285 (Bare - Electric Start)	GRA68593/EA 17B485 (Complete)
TTI14068/EA 433-802 (55 GL)		GRA10583/EA 249617 (Complete)	GRA38986/EA 16U282 (Complete)	GRA68595/EA 17B488 (Big 250 - Electric Start)
		GRA38992/EA 16U288 (Complete - Electric Start)	GRA38990/EA 16U286 (Complete - Electric Start)	GRA39425/EA 25M283 (Big 250 - ES & Monark)
		GRA47161/EA 16U780 (Big 250)	GRA47164/EA 16U783 (Big 250)	
		GRA47135/EA 16U781 (Big 250 - Electric Start)	GRA47166/EA 16U784 (Big 250 - Electric Start)	
		GRA13986/EA 249767 (OEM Kit)		

ROOFING SPRAYERS continued

			
			
Product Official Name	GH 1017	GH 2570	GH 5040
Max GPM	16.5	7	3.5
Max Tip Size (in.)			
Max psi	1,000	2,500	5,000
Motor Size / Type	Honda 390 cc (13.0 HP)	Honda 390 cc (13.0 HP)	Honda 390 cc (13.0 HP)
Weight (lbs.)	473	471	438
Tip Included			
Gun Included			
Hose Included			
Gun Support			
PPG # Vendor #	GRA38980/EA 16U277 (Bare - Electric Start)	GRA38981/EA 16U278 (Bare - Electric Start)	GRA38983/EA 16U280 (Bare - Electric Start)
			GRA47163/EA 16U782 (Big 250 - Electric Start)











**STRIPING
SPRAYERS**

					
					
Product Official Name	PowrLiner 850	FieldLazer™ S90	FieldLazer S100	PowrLiner 3500	LineLazer® 3400
Max GPM	0.33			0.75	0.75
Max Tip Size (in.)	0.021	0.017	0.021	0.027	0.027
Max psi	3,000	900	900	3,300	3,300
Power Source	Gas	12V Battery	Gas	Gas	Gas
Motor Size / Type	37.7cc		Honda GX35	Honda GX 120 cc	Honda 120 cc (4.0 hp)
Weight (lbs.)	65	60	80	142	160
Gun Support	1	1	1	1	1
PPG # Vendor #	WST19344/EA 0290005A (Standard)	GRA26111/EA 24N950 (Standard)	GRA08874/EA 248942 (Standard)	TTI26535/EA 537015 (Standard)	GRA38913/EA 25M224 (Standard)

STRIPING SPRAYERS continued



Product Official Name	PowrLiner 2850	PowrLiner 4955	NEW PowrLiner 4500 - 2 Gun	LineLazer V 3900
Max GPM	0.92	1.25	1.25	1.25
Max Tip Size (in.)	0.03	0.033	0.036	0.036
Max psi	3,300	3,300	3,300	3,300
Power Source	Gas	Gas	Gas	Gas
Motor Size / Type	Honda GX 120 cc	Honda GX 120 cc	Honda GX 160 cc	Honda 120 cc (4.0 hp)
Weight (lbs.)	172	324	234	230
Gun Support	2 (.019 Tip)	2 (.025 Tip)	2 (.025 Tip)	2 (.025 Tip)
PPG # Vendor #	TTI20077/EA 0290009H (Standard)	TTI22520/EA 0290052H (Standard)	2407312 - SmartArm	GRA31997/EA 17H450 (Standard)
			2407313 - No SmartArm	GRA31999/EA 17H452 HP Automatic - Guns - 1 Auto 1 Manual
				GRAX9631/EA 17U804 HP Automatic - Guns - 1 Auto 1 Manual & LG
				GRA32000/EA 17H453 HP Automatic - Guns - 2 Auto
				GRAX9630/EA 17U805 HP Automatic - Guns - 2 Auto & LG

				
				
LineLazer V 130 HS	LineLazer V 5900	LineLazer V 200HS	LineLazer V 200DC	PowrLiner 6955 - 2 Gun
1.3	1.6	2.15	2.15	2.25
0.037	0.043	0.047	0.047	0.047
3,300	3,300	3,300	3,300	3,300
Gas	Gas	Gas	Gas	Gas
Honda 120 cc (4.0 hp)	Honda 160 cc (5.5 hp)	Honda 200 cc (6.5 hp)	Honda 200 cc (6.5 hp)	Honda GX 160 cc (Electric Start)
263	250	306	381	334
2 (.029 Tip)	2 (.029 Tip)	2 (.034 Tip)	2 (.034 Tip)	2 (.031 Tip)
GRA31995/EA 17H448 (Standard)	GRA32002/EA 17H455 (Standard)	GRA32007/EA 17H461 (Standard)	GRAX82727/EA 17Y231 (Standard)	TTI22521/EA 0290053H (Standard)
GRAX9629/EA 17U802 HP Automatic - Guns - 2 Auto	GRA32004/EA 17H457 HP Automatic - Guns - 1 Auto 1 Manual	GRA32009/EA 17H463 HP Automatic - Guns - 1 Auto 1 Manual	GRAX85063/EA 17Y269 HP Automatic - Guns - 2 Auto	
	GRAX9629/EA 17U802 HP Automatic - Guns - 1 Auto 1 Manual & LG	GRA32010/EA 17H464 HP Automatic - Guns - 2 Auto	GRAX85066/EA 17Y270 HP Reflective - Guns - 2 Auto 1 Bead Tank	
	GRA32005/EA 17H458 HP Automatic - Guns - 2 Auto	GRA32011/EA 17H465 HP Reflective - Guns - 2 Auto 1 Bead Tank		
	GRAX9632/EA 17U803 HP Automatic - Guns - 2 Auto & LG			

STRIPING SPRAYERS *continued*



Product Official Name	PowrLiner 8955 - 2 Gun	LineLazer V 250SPS	LineLazer V 250DC	LineLazer V ES 1000
Max GPM	2.5	2.5	2.5	0.6
Max Tip Size (in.)	0.054	0.055	0.055	0.025
Max psi	3,300	3,300	3,300	3,300
Power Source	Gas	Gas	Gas	Battery 100AH AGM
Motor Size / Type	Honda GX 200 cc (Electric Start)	Honda 390 cc (13 HP) Electric Start	Honda 390 cc (13 HP) Electric Start	MaxPower Brushless DC
Weight (lbs.)	339	666	752	340
Gun Support	2 (.038 Tip)	5 (.021 Tip)	5 (.021 Tip)	1 (.025 Tip)
PPG # Vendor #	TTI22522/EA 0290054H (Standard)	GRA32013/EA 17H467 HP Automatic - Guns - 2 Auto	GRA32016/EA 17H471 HP Automatic - Guns - 2 Auto	GRA38968/EA 25M226 1 Battery
		GRA34018/EA 17J951 HP Reflective - Guns - 2 Auto 1 Bead Tank	GRA32017/EA 17H472 HP Automatic - Guns - 3 Auto	GRAX85600/EA 25N784 2 Batteries
		GRAX9054/EA 25D345 HP Reflective - Guns - 2 Auto 1 Bead Tank LG	GRA32018/EA 17H473 HP Reflective - Guns - 2 Auto 2 Bead Tank	
		GRA32015/EA 17H469 HP Reflective - Guns - 2 Auto 2 Bead Tank	GRAX9055/EA 25D343 HP Reflective - Guns - 2 Auto 2 Bead Tank LG	
		GRAX9052/EA 25D340 HP Reflective - Guns - 2 Auto 2 Bead Tank LG	GRA32019/EA 17H474 HP Reflective - Guns - 3 Auto 2 Bead Tank	
			GRAX9056/EA 25D344 HP Reflective - Guns - 3 Auto 2 Bead Tank LG	



LineLazer V ES 2000

**LineDriver™
Ride-On System**

Lazy Liner

1.1

0.033

3,300

Battery
100AH AGM

Gas or Battery

Gas

MaxPower Brushless DC

Honda 160 cc (5.5 hp) - LineDriver
Honda 200 cc (6.5 hp) - LineDriver HD

430

LineDriver: 265
LineDriver HD: 275
LineDriver ES: 550

2 (.025 Tip)

GRA82283/EA
25N550
2 Batteries

GRA26703/EA
262004
(Gas - Honda 160 cc)

TTI21962/EA
0290040Z
(Gas - Honda GX160)

GRAX82285/EA
25N551 - 2 Batteries
HP Automatic -
Guns - 1 Auto 1 Manual

GRA26702/EA
262005
(Gas - Honda 200 cc)

TTI21963/EA
0290041Z
(Gas - Honda GX200)







GRAX85070/EA
25N559 - 2 Batteries
HP Automatic -
Guns - 1 Auto 1 Manual & LG



GRA82944/EA
25N555
(Electric Battery - 100AH)

GRAX82286/EA
25N552 - 2 Batteries
HP Automatic - Guns - 2 Auto

GRAX85073/EA
25N560
2 Batteries - HP Automatic -
Guns - 2 Auto & LG

DISINFECTANT EQUIPMENT

Production Needs	Up to 15 Gallons Per Week		
	 	 	 
Product Official Name	SaniSpray HP™ 20 Airless Corded	SaniSpray HP 20 Airless Cordless	SaniSpray HP 20 Electrostatic
Max psi	1,000	1,000	1,000
Pump Type & Construction	Triax™ airless triple piston pump	Triax airless triple piston pump	Triax airless triple piston pump
Power Source	Electric	2 DeWALT 20V Batteries	2 DeWALT 20V Batteries
Motor Size / Type	1/4 HP Brushed AC	1/4 HP Brushless DC	1/4 HP Brushed DC
Weight (lbs.)	4.6	5.25	6.25
Disinfectant Compatibility	All EPA List-N & Health Canada	All EPA List-N & Health Canada	All EPA List-N & Health Canada
	No alcohol-based (flammable)		No alcohol-based (flammable)
PPG # Vendor #	GRA06108/EA 25R790	25R791 GRA06107/EA (Sprayer, Batteries, Charger Only)	GRA16777/EA 25T589 (Sprayer, Batteries, Charger Only)
		GRA17438/EA 25A255 (ProPak™ System)	GRA17431/EA 20A243 (ProPak™ System)

Up to 50 Gallons Per Week	Up to 100 Gallons Per Week	Up to 500 Gallons Per Week
		
SaniSpray HP 65	SaniSpray HP 130	SaniSpray HP 750
1,000	1,000	1,200
ProX Power-Piston Pump	Endurance Long Life Piston Pump	550 cc Displacement
Electric OR 2 Dewalt 20V Batteries	Electric	Electric
1/2 HP DC	1.8 HP Brushless DC	200 -240 VAC Single Phase Driver
27	77	308
All EPA List-N & Health Canada	All EPA List-N & Health Canada	All EPA List-N & Health Canada
GRA06113/EA 25R792	GRA06112/EA 25R793	GRA07470/EA 273216 (4 Gun)
		GRA07468/EA 273217 (8 Gun)



Contractor FTx



Contractor



Contractor PC



Contractor PC Compact



Silver Plus



Flex Plus Gun

Contractor FTx - Good		
VENDOR #	PPG #	DESCRIPTION
288430	GRA21581/EA	Contractor FTx Gun with RAC X LTX - 4-Finger
288431	GRA21582/EA	Contractor FTx Gun with RAC 5 - 4-Finger
288429	GRA21459/EA	Contractor FTx Gun with RAC X - 2-Finger
Contractor - Better		
288420	GRA21576/EA	Contractor Gun with RAC X LTX Tip - 2 Finger
288421	GRA21577/EA	Contractor Gun with RAC 5 Tip - 2-Finger
288425	GRA21411/EA	Contractor Gun with RAC X LTX Tip - 4-Finger
Contractor PC - Best		
17Y042	GRA81571/EA	Contractor PC Gun with RAC X LTX Tip - Adjustable Finger
17Y043	GRA81572/EA	Contractor PC Gun with RAC X LP Tip - Adjustable Finger
17Y470	GRA85084/EA	Contractor PC Gun with RAC X FFLP Tip - Adjustable Finger
Contractor PC Compact		
19Y349	GRA98269/EA	Contractor PC Compact Gun with RAC X LTX Tip - Adjustable Finger
19Y350	GRA98270/EA	Contractor PC Compact Gun with RAC X LP Tip - Adjustable Finger
19Y443	GRA98276/EA	Contractor PC Compact Gun with RAC X FFLP Tip - Adjustable Finger
Silver Plus		
243283	GRA92265/EA	Silver Plus Gun with RAC 5 Tip
246240	GRA91232/EA	Silver Plus Gun with RAC X LTX Tip
Flex Plus		
246468	GRA91306/EA	Flex Plus Gun with RAC X LTX Tip
248157	GRA03599/EA	Flex Plus Gun with RAC 5 LineLazer Tip



SPRAY GUNS

RX-80 (Good)		
VENDOR #	PPG #	DESCRIPTION
538005	TTI24057/EA	RX-80 Gun 4 Finger w/TR-1 Tip
538009	TTI24060/EA	RX-80 Gun 4 Finger (No Tip)
538006	TTI24056/EA	RX-80 Gun 2 Finger w/TR-1 Tip
538014	TTI24256/EA	RX-80 Gun 2 Finger (No Tip)
RX-Pro (Better)		
538020	TTI23489/EA	RX-Pro Gun w/TR-1 517 Tip
RX-Apex (Best)		
538070	TTI27376/EA	RX-Apex Gun (UnFiltered) w/TR-1 Tip
538075	TTI27377/EA	RX-Apex Gun (Filtered)
Specialty		
550060	WST21232/EA	S-3 Gun w/TR' Tip
550-260	TTI41408/EA	S-7 Gun w/1/4" Swivel
550-270	TTI41403/EA	S-7 Gun w/3/8" Swivel
550-475	TTI41823/EA	LX-70 Inline Gun
289013	TTI22175/EA	M-4 Gun
289014	TTI22176/EA	M-8 Gun



RX-80



RX-Pro



RX-Apex

GUN HOSE KITS



Contractor Gun Hose Kit with RAC X LTX

Contractor FTx		
VENDOR #	PPG #	DESCRIPTION
288493	GRA21553/EA	Contractor FTx Gun Hose Kit with RAC X LTX Tip
288497	GRA21559/EA	Contractor FTx Gun Hose Kit with RAC 5 Tip
Contractor		
288489	GRA21549/EA	Contractor Gun Hose Kit with RAC X LTX Tip - 1/4"
288496	GRA21558/EA	Contractor Gun Hose Kit with RAC 5 Tip - 1/4"
288490	GRA21551/EA	Contractor Gun Hose Kit with RAC X LTX Tip - 3/8"
288500	GRA21563/EA	Contractor Gun Hose Kit with RAC X LTX Tip - 3/8"
288501	GRA21564/EA	Contractor Gun Hose Kit with LTX FFLP Tip - 3/16"
Contractor PC		
17Y046	GRAX81951/EA	Contractor PC Gun Hose Kit RAC X LTX Tip - 1/4"
17Y048	GRAX81952/EA	Contractor PC Gun Hose Kit RAC X LTX Tip - 3/8"
17Y051	GRAX81955/EA	Contractor PC Gun Hose Kit RAC X LP Tip - 1/4"
17Y220	GRAX81953/EA	Contractor PC Gun Hose Kit RAC X FFLP Tip - 3/8"
17Z222	GRAX86682/EA	Contractor PC Gun Hose Kit RAC X LTX Tip - BULK MUST ORDER 8
Contractor PC Compact - NEW		
19Y489	GRA98596/EA	Contractor PC Compact Gun Hose Kit with RAC X LP Tip
19Y490	GRA98593/EA	Contractor PC Compact Gun Hose Kit with RAC X FFLP Tip
19Y475	GRA98595/EA	Contractor PC Compact Gun Hose Kit with RAC X LTX Tip
19Y444	GRA98273/EA	Contractor PC Compact Gun Whip Kit with RAC X LTX Tip
19Y445	GRA98274/EA	Contractor PC Compact Gun Whip Kit with RAC X LP Tip
19Y446	GRA98275/EA	Contractor PC Compact Gun Whip Kit with RAC X FFLP Tip
19Y568	GRA99354/EA	Contractor PC Compact Gun Hose Kit with RAC X LTX Tip - BULK MUST ORDER 8
Silver Plus		
287041	GRA91250/EA	Silver Plus Gun Hose Kit with RAC X LTX Tip 1/4"
287042	GRA91251/EA	Silver Plus Gun Hose Kit with RAC X LTX Tip 3/8"
287850	GRA12020/EA	Silver Plus Gun Hose Kit with RAC X LTX Tip 3/8"
243321	GRA92277/EA	Silver Plus Gun Hose Kit with RAC 5 Tip 1/4"
287823	GRA11916/EA	Silver Plus Gun Hose Kit with RAC X FFLP Tip 3/16"
Texture Guns		
287095	GRA91307/EA	Flex Plus Gun Hose Kit with RAC X LTX - 1/4"
287851	GRA12021/EA	Flex Plus Gun Hose Kit with RAC X LTX - 3/8"
241338	GRA88938/EA	HD Blue Texture Gun Hose Kit with RAC X LTX - 3/8"
287852	GRA12022/EA	HD Texture Gun Hose Kit with RAC X LTX - 3/8"



Contractor PC Compact Gun Hose Kit with RAC X FFLP Tip



Contractor PC Gun Hose Kit with RAC X LTX



Silver Plus Gun Hose Kit with RAC X LTX Tip



Flex Plus Gun Hose Kit with RAC X LTX Tip

TITAN GUN HOSE KITS



w/TR-1 Tip

RX-80		
VENDOR #	PPG #	DESCRIPTION
538010	TTI24048/EA	RX-80 GHT Kit 4 Finger w/TR-1 Tip
538011	TTI24049/EA	RX-80 GHT Kit 4 Finger w/SC-6+ Tip
RX-Pro		
0538022A	TTI24050/EA	Titan RX-Pro GHT Kit (TR-1)
538033	TTI27437/EA	Titan RX-Pro GHT Kit (HEA)
RX-Apex		
538072	TTI27479/EA	RX-Apex GHT Kit (Unfiltered)
538073	TTI27480/EA	RX-Apex HP GHT Kit (Unfiltered)
538076	TTI27477/EA	RX-Apex GHT Kit (Filtered) w/TR-1 Tip
538077	TTI27478/EA	RX-Apex GHT Lit (Filtered) w/HEA Tip
Various including HVLP		
550065	TTI21233/EA	S-3 GHT Kit w/TR-1 Tip
550075	TTI21235/EA	S-5 GHT Kit w/TR-1 Tip
524041	TTI19729/EA	Maxum II Gun w/Cup
524027	WST19455/EA	Elite Gun w/Cup



GRACO ACCESSORIES



1/4" x 50' BlueMax II Hose

BlueMax II		
214981	GRA43188/EA	3/16" x 15' BlueMax II Hose 3300 psi
214698	GRA01514/EA	3/16" x 25' BlueMax II Hose 3300 psi
214697	GRA61876/EA	3/16" x 50' BlueMax II Hose 3300 psi
223756	GRA53262/EA	1/4" x 15' BlueMax II Hose 3300 psi
240793	GRA86255/EA	1/4" x 25' BlueMax II Hose 3300 psi
240794	GRA86256/EA	1/4" x 50' BlueMax II Hose 3300 psi
223771	GRA41873/EA	1/4" x 100' BlueMax II Hose 3300 psi
240796	GRA86258/EA	3/8" x 25' BlueMax II Hose 3300 psi
240797	GRA86259/EA	3/8" x 50' BlueMax II Hose 3300 psi
241275	GRA87383/EA	3/8" x 100' BlueMax II Hose 3300 psi
Whip Hoses		
238358	GRA70709/EA	3/16" x 3' Whip Hose 3300 psi
238959	GRA76680/EA	3/16" x 4.5' Whip Hose 3300 psi
238359	GRA70706/EA	3/16" x 6' Whip Hose 3300 psi
25C827	GRA64089/EA	1/8" x 3' Whip Hose 3300 psi
25C832	GRA64091/EA	1/8" x 6' Whip Hose 3300 psi



3/16" x 3' Whip Hose

SPRAY GUNS, TIPS & ACCESSORIES



Throat Seal Liquid - 8oz



3' Pole Gun

High Pressure Hoses		
VENDOR #	PPG #	DESCRIPTION
277249	GRA11408/EA	1/4" x 3' Whip Hose 4000 psi
277250	GRA11409/EA	1/4" x 50' Whip Hose 4000 psi
277351	GRA18847/EA	3/8" x 3' Hose 4000 psi
277251	GRA11410/EA	3/8" x 50' Hose 4000 psi
277253	GRA11413/EA	1/2" x 50' Hose 4000 psi
Xtreme-Duty Hoses		
H42550	GRA11181/EA	1/4" x 50' Xtreme-Duty Hose 4500 psi
H4251X	GRA11185/EA	1/4" x 100' Xtreme-Duty Hose 4500 psi
H43803	GRA11187/EA	3/8" x 3' Xtreme-Duty Hose 4500 psi
H53850	GRA11218/EA	3/8" x 50' Xtreme-Duty Hose 5600 psi
H4381X	GRA11196/EA	3/8" x 100' Xtreme-Duty Hose 4500 psi
H45050	GRA11202/EA	1/2" x 100' Xtreme-Duty Hose 4500 psi
H4501X	GRA11205/EA	1/2" x 100' Xtreme-Duty Hose 4500 psi
Liquids		
206994	GRA30969/EA	Throat Seal Liquid - 8oz
243103	GRA91739/EA	Pump Armor™ Fluid - quart
Extensions		
287019	GRA91202/EA	RAC X Tip Extension - 10"
287020	GRA91208/EA	RAC X Tip Extension - 15"
287021	GRA91209/EA	RAC X Tip Extension - 20"
287022	GRA91210/EA	RAC X Tip Extension - 30"
243295	GRA92095/EA	RAC 5 Tip Extension - 10"
243296	GRA92096/EA	RAC 5 Tip Extension - 15"
243297	GRA92097/EA	RAC 5 Tip Extension - 20"
243298	GRA92098/EA	RAC 5 Tip Extension - 30"
Pole Guns		
287023	GRA91211/EA	3' Pole Gun RAC X
287024	GRA91213/EA	6' Pole Gun RAC X
287030	GRA91656/EA	CleanShot™ Shutoff Valve RAC X
244161	GRA96217/EA	Contractor In-Line Valve
Spray Rollers		
24U170	GRA67098/EA	9" JetRoller™ Kit with Fixed Extension
24U172	GRA67100/EA	9" JetRoller Kit with Fixed Extension and In-Line Valve
24V926	GRA59311/EA	9.5" JetRoller Kit with Fixed Extension and In-Line Valve (Canada Only)
24W128	GRA68759/EA	18" JetRoller Kit with Fixed Extension and In-Line Valve



RAC X Tip Extension - 20"



9" JetRoller Kit with Fixed Extension and In-Line Valve

TITAN ACCESSORIES



1/4" x 50' 3300 psi Hose

Whip Hoses		
VENDOR #	PPG #	DESCRIPTION
550-240	TTI06276/EA	3' x 3/16 Whip Hose
316-506	TTI03869/EA	5' x 3/16 WhipHose
550-222	TTI06268/EA	9' x 3/16 WhipHose
Hoses		
316-505	TTI03868/EA	1/4" x 50' 3300 psi Hose
291006	WST13450/EA	3/8" x 50' 3300 psi Hose
286498	TTI20542/EA	1/4" x 50' 3600 psi Hose
286499	TTI20543/EA	3/8 x 50' 3600 psi Hose
2389428	TTI22558/EA	1/4" X 3' 4500 psi Hose
2389430	TTI22559/EA	1/4" X 6' 4500 psi Hose
2389429	TTI22560/EA	1/4" X 50' 4500 psi Hose
2389427	TTI22561/EA	1/4" X 100' 4500 psi Hose
2389440	TTI22567/EA	1/4" X 3' 6500 psi Hose
2389442	TTI22568/EA	1/4" X 6' 6500 psi Hose
2389441	TTI22569/EA	1/4" X 50' 6500 psi Hose
2389439	TTI22570/EA	1/4" X 100' 6500 psi Hose
2389450	TTI22549/EA	1/4" X 3' 7500 psi Hose
2389452	TTI22550/EA	1/4" X 6' 7500 psi Hose
2389451	TTI22551/EA	1/4" X 50' 7500 psi Hose
2389449	TTI22552/EA	1/4" X 100' 7500 psi Hose
2389436	TTI22562/EA	3/8" X 6' 4500 psi Hose
2389434	TTI22563/EA	3/8" X 50' 4500 psi Hose
2389432	TTI22564/EA	3/8" X 100' 4500 psi Hose
2389446	TTI22571/EA	3/8" X 6' 6500 psi Hose
2389445	TTI22572/EA	3/8" X 50' 6500 psi Hose
2389444	TTI22573/EA	3/8" X 100' 6500 psi Hose
2389456	TTI22553/EA	3/8" X 6' 7500 psi Hose
2389455	TTI22554/EA	3/8" X 50' 7500 psi Hose
2389453	TTI22555/EA	3/8" X 100' 7500 psi Hose
2389425	TTI22565/EA	1/2" X 50' 4500 psi Hose
2389424	TTI22566/EA	1/2" X 100' 4500 psi Hose
2389438	TTI22574/EA	1/2" X 50' 6500 psi Hose
2389437	TTI22575/EA	1/2" X 100' 6500 psi Hose
2389448	TTI22556/EA	1/2" X 50' 7500 psi Hose
2389447	TTI22557/EA	1/2" X 100' 7500 psi Hose

SPRAY GUNS, TIPS & ACCESSORIES



Liquid Shield 10qt.



12" Gun Extension (3600 PSI)



Liquids		
VENDOR #	PPG #	DESCRIPTION
314-482	TTI16507/EA	Liquid Shield 10qt.
314-480	TTI16509/EA	Piston Lube 8oz.
Extensions		
651-070	TTI41299/EA	6" Gun Extension (3600 PSI)
651-071	TTI41300/EA	12" Gun Extension (3600 PSI)
651-072	TTI41302/EA	18" Gun Extension (3600 PSI)
651-073	TTI41303/EA	24" Gun Extension (3600 PSI)
611-280	TTI42297/EA	6" Gun Extension (7700 PSI)
611-281	TTI41881/EA	12" Gun Extension (7700 PSI)
611-282	TTI41914/EA	18" Gun Extension (7700 PSI)
611-283	TTI41898/EA	24" Gun Extension (7700 PSI)
538029	TTI42272/EA	Swivel Head - Female (Gun Extension)
711-600	TTI10168/EA	Swivel Head - Male (Gun Extension)
310-381-1	TTI16405/EA	1-1/2' Extension Pole, HT, #1 Nut
310-383-1	TTI16420/EA	3' Extension Pole, HT, #1 Nut
310-386-1	TTI16421/EA	6' Extension Pole, HT, #1 Nut
310-390	TTI38456/EA	3' H.D. Extension Pole w/Swivel
279976	WST12576/EA	6' H.D. Extension Pole w/Swivel
310-072-1	TTI03207/EA	Angle Adapter
Spray Roller & Guide		
538900	TTI23488/EA	Titan SprayGuide
2403959	TTI27889/EA	Spray Roller & Spray Guide w/Swivel
2404013	TTI27890/EA	Spray Roller & Spray Guide, Swivel w/Pole (Combo Kit)
2403780	TTI27891/EA	Spray Roller Frame Only
2404445	TTI27895/EA	Inner Feed Roller
0155206K	TTI55206/EA	9"x3/8" Roller Cover
0155208B	TTI55208/EA	9"x3/4" Roller Cover



Piston Lube 8oz.



TIP INDEX

Trouble finding the right tip size for your specific job and coating?

PPG offers the full assortment of tip sizes, so no matter what your job requires, find your specific tip here!



PROVEN CHOICE OF PROFESSIONAL CONTRACTORS





CHOOSE THE MOST PRODUCTIVE SPRAY TIP FOR YOUR JOB







Choosing the right tip for the job will determine the quality of your finish and help you save time and money. Each Graco spray tip is 100% tested for flow rate to meet the tough standards of painting contractors and ensure the quality you've come to expect from Graco.

- Use smaller orifice sizes when applying light viscosity materials such as stains and lacquers
- Use larger orifice sizes for heavier viscosity coatings such as latex

MATERIALS RECOMMENDED TO BE SPRAYED	TIP SIZES (IN)
Oil-base stains, lacquers, and clear coats	0.009 - 0.013
Oil-base enamels and industrial enamels	0.013 - 0.015
Latex paint	0.015 - 0.019
Heavy latex and smooth elastomers	0.021 - 0.025
Elastomers and block fillers	0.025 - 0.039

GRACO SPRAY TIPS ARE BUILT TO THE HIGHEST STANDARDS AND ENSURE THE BEST FINISH IN THE INDUSTRY.





GOOD	BETTER	BEST
		
RAC® 5	RAC X™ LTX	RAC X LOW PRESSURE
Precision spray tip provides excellent fan pattern life and high quality finish	Next generation with 50% longer fan pattern life	Spray at lower pressure—less overspray, longest tip life. Produces softer edges for perfect airless finish
4050 psi (280 bar, 28.0 MPa)		
Latex, Oil-based Paints, Elastomeric, Block Filler		
Residential, Commercial, Interior and Exterior Applications		
286xxx, Guard (Orange) 243161	LTXxxx, Guard (Blue) 246215	LPxxx, Guard (Blue) 246215

SPECIALTY SPRAY TIPS					
					
RAC X FINE FINISH	RAC X WIDE RAC	LINELAZER	XTREME HEAVY-DUTY	CONTRACTOR FLAT TIPS	FINE FINISH FLAT TIPS
Dual orifice for fine finish applications with thin material	Produces a 24 in (610 mm) fan pattern to finish the job in half the time	Creates a laser-sharp line with no fuzzy edges for line striping	High pressure (7250 psi, 500 bar) for use with King and Xtreme sprayers	Disposable, non-reversible tip for continuous spraying on a job	Fine finish, non-reversible tip for wood and metal finishing work
4050 psi (280 bar, 28.0 MPa)			7250 psi (500 bar, 50.0 MPa)	5000 psi (345 bar, 34.5 MPa)	
Lacquer, varnish, stain, enamel paint	Latex, oil-based paints, elastomeric, block filler	Heavy water-based to thin alkyd traffic paints	Virtually all paint coatings—solvent and water-based	Architectural Coatings	Varnish, urethans, lacquers and enamels
Trim, molding, cabinets, woodwork, metal	New construction and high production with large surfaces	Parking lots, roads, warehouse floors, crosswalks, athletic fields	Bridges, tanks, structural steel and roofing	New Construction	Woodwork, metal, top coats
FFLPxxx, Guard (Blue) 246215	WRxxxx, Guard (Blue) 246215	LL5xxx, Guard (Orange) 243161	XHDxxx, Guard (Gray) XHD001	269xxx, Guard 220251	163xxx, Guard 220247



DESIGNED FOR PROS. BUILT FOR PRODUCTIVITY.

INDUSTRY LEADING TIP TECHNOLOGY

	GOOD	BETTER	BEST	SPECIALTY	SPECIALTY
	 <p>SC-6+ REVERSIBLE AIRLESS TIP</p>	 <p>TR¹ REVERSIBLE AIRLESS TIP</p>	 <p>TR¹ HEA™ HIGH EFFICIENCY AIRLESS TIP</p>	 <p>SC-6+ SYNERGY™ FINE FINISH AIRLESS TIP</p>	 <p>TR¹ HIGH PRESSURE AIRLESS TIP</p>
Features and Benefits	<p>High Quality, Long Lasting Reversible Tip</p> <ul style="list-style-type: none"> ■ The industry's longest lasting orifice ■ Up to 22% wider fan pattern 	<p>Best Overall Performing Tip in the Industry</p> <ul style="list-style-type: none"> ■ Fan pattern stays wider longer ■ An orifice that outlasts competitive tips delivering consistent film thickness and less wasted paint 	<p>Revolutionary Low Pressure Tip</p> <ul style="list-style-type: none"> ■ Optimized to spray all architectural paints and coatings at 1000 PSI at production speed ■ Decreases overspray up to 55% ■ 2X the life of a standard reversible tip 	<p>Delivers the Finest Finish</p> <ul style="list-style-type: none"> ■ Atomizes coatings up to 27% finer than with a standard tip ■ Up to 22% wider fan pattern 	<p>Better Quality and Performance at High Pressures</p> <ul style="list-style-type: none"> ■ Optimized to spray the heaviest coatings at the highest pressures ■ Consistent fan pattern width ■ Sprays a uniform paint thickness for the life of the tip
Typical Applications	Residential / Commercial Interior / Exterior	Residential / Commercial Interior / Exterior	Residential / Commercial Interior / Exterior	Fine Finishing Exterior	Commercial / Industrial
Recommended working Pressure	1500–5000 PSI	1500–5000 PSI	800–1200 PSI	1200–1800 PSI	3000–7700 PSI
Fan Pattern	High Quality	Premium	Premium	High Quality	Premium High Pressure

GRASP THE FUTURE OF AIRLESS SPRAY TECHNOLOGY

HIGH QUALITY

RX-80™
AIRLESS SPRAY GUN



-  **COMFORT GRIP™**
Ergonomic design brings added comfort.
-  **LONGER LIFE PACKING KIT**
Lasts longer with improved performance.
-  **ONBOARD TOOLS**
Smart tools that make jobsite life easier.

PREMIUM

RX-PRO®
AIRLESS SPRAY GUN



-  **ULTRA-LIGHT TRIGGER**
30% lighter than the competitor's trigger pull decreasing fatigue.
-  **FINGERPRINT GRIP®**
Customize the grip to comfortably fit any painter's hand.
-  **2X LIFE**
INFINITY PACKING®
2X the gun life by reversing the seat and changing the ball.
-  **ONBOARD TOOLS**
Smart tools that make jobsite life easier.

GRACO TIP INDEX



RAC 5
SwitchTip

RAC 5 SwitchTips								
PART #	PPG SKU	SIZE	PART #	PPG SKU	SIZE	PART #	PPG SKU	SIZE
286109	GRA91379/EA	109	286419	GRA91413/EA	419	286611	GRA91447/EA	611
286111	GRA91380/EA	111	286421	GRA91414/EA	421	286613	GRA91448/EA	613
286113	GRA91381/EA	113	286423	GRA91415/EA	423	286615	GRA91449/EA	615
286115	GRA91382/EA	115	286425	GRA91416/EA	425	286617	GRA91450/EA	617
286119	GRA91383/EA	119	286427	GRA91417/EA	427	286619	GRA91451/EA	619
286207	GRA91385/EA	207	286429	GRA91418/EA	429	286621	GRA91452/EA	621
286209	GRA91386/EA	209	286431	GRA91419/EA	431	286623	GRA91453/EA	623
286211	GRA91387/EA	211	286433	GRA91420/EA	433	286625	GRA91454/EA	625
286213	GRA91388/EA	213	286435	GRA91421/EA	435	286627	GRA91455/EA	627
286215	GRA91389/EA	215	286439	GRA91422/EA	439	286629	GRA91456/EA	629
286217	GRA91390/EA	217	286443	GRA91423/EA	443	286631	GRA91457/EA	631
286219	GRA91391/EA	219	286451	GRA91424/EA	451	286633	GRA91458/EA	633
286221	GRA91392/EA	221	286455	GRA91425/EA	455	286635	GRA91459/EA	635
286223	GRA91393/EA	223	286509	GRA91426/EA	509	286645	GRA91460/EA	645
286225	GRA91394/EA	225	286511	GRA91428/EA	511	286655	GRA91461/EA	655
286235	GRA91395/EA	235	286513	GRA91429/EA	513	286665	GRA91462/EA	665
286307	GRA91396/EA	307	286515	GRA91430/EA	515	286721	GRA91463/EA	721
286309	GRA91397/EA	309	286517	GRA91431/EA	517	286723	GRA91464/EA	723
286311	GRA91398/EA	311	286519	GRA91433/EA	519	286725	GRA91465/EA	725
286313	GRA91399/EA	313	286521	GRA91434/EA	521	286729	GRA91466/EA	729
286315	GRA91400/EA	315	286523	GRA91435/EA	523	286735	GRA91467/EA	735
286317	GRA91401/EA	317	286525	GRA91436/EA	525	286815	GRA91468/EA	815
286319	GRA91402/EA	319	286527	GRA91437/EA	527	286817	GRA91469/EA	817
286321	GRA91403/EA	321	286529	GRA91438/EA	529	286819	GRA91470/EA	819
286323	GRA91404/EA	323	286531	GRA91439/EA	531	286821	GRA91471/EA	821
286325	GRA91405/EA	325	286533	GRA91440/EA	533	286827	GRA91472/EA	827
286327	GRA91406/EA	327	286535	GRA91441/EA	535	286831	GRA91473/EA	831
286409	GRA91408/EA	409	286543	GRA91442/EA	543	286835	GRA91475/EA	835
286411	GRA91409/EA	411	286551	GRA91443/EA	551	286917	GRA91476/EA	917
286413	GRA91410/EA	413	286555	GRA91444/EA	555	286935	GRA91477/EA	935
286415	GRA91411/EA	415	286563	GRA91445/EA	563			
286417	GRA91412/EA	417	286609	GRA91446/EA	609			



RAC X LTX SwitchTips								
PART #	PPG SKU	SIZE	PART #	PPG SKU	SIZE	PART #	PPG SKU	SIZE
LTX109	GRA26724/EA	109	LTX415	GRA88942/EA	415	LTX555	GRA26778/EA	555
LTX111	GRA26725/EA	111	LTX417	GRA88943/EA	417	LTX561	GRA26779/EA	561
LTX115	GRA26726/EA	115	LTX419	GRA88945/EA	419	LTX611	GRA26780/EA	611
LTX207	GRA26727/EA	207	LTX421	GRA08665/EA	421	LTX613	GRA26783/EA	613
LTX209	GRA07970/EA	209	LTX423	GRA09117/EA	423	LTX615	GRA07982/EA	615
LTX211	GRA07089/EA	211	LTX425	GRA26744/EA	425	LTX617	GRA88956/EA	617
LTX213	GRA07098/EA	213	LTX427	GRA26746/EA	427	LTX619	GRA88957/EA	619
LTX215	GRA07973/EA	215	LTX429	GRA26747/EA	429	LTX621	GRA88958/EA	621
LTX217	GRA07975/EA	217	LTX431	GRA26748/EA	431	LTX623	GRA88959/EA	623
LTX219	GRA09114/EA	219	LTX433	GRA26749/EA	433	LTX625	GRA09125/EA	625
LTX221	GRA26728/EA	221	LTX435	GRA26751/EA	435	LTX627	GRA09126/EA	627
LTX225	GRA26730/EA	225	LTX509	GRA26759/EA	509	LTX629	GRA09130/EA	629
LTX227	GRA26731/EA	227	LTX511	GRA07097/EA	511	LTX631	GRA09133/EA	631
LTX231	GRA26732/EA	231	LTX513	GRA07102/EA	513	LTX635	GRA09134/EA	635
LTX309	GRA07976/EA	309	LTX515	GRA88948/EA	515	LTX639	GRA26789/EA	639
LTX311	GRA07095/EA	311	LTX517	GRA88949/EA	517	LTX641	GRA26794/EA	641
LTX313	GRA07099/EA	313	LTX519	GRA88950/EA	519	LTX643	GRA26795/EA	643
LTX315	GRA88960/EA	315	LTX521	GRA88954/EA	521	LTX645	GRA26796/EA	645
LTX317	GRA88941/EA	317	LTX523	GRA88955/EA	523	LTX647	GRA29133/EA	647
LTX319	GRA07977/EA	319	LTX525	GRA09118/EA	525	LTX651	GRA26797/EA	651
LTX321	GRA08660/EA	321	LTX527	GRA09121/EA	527	LTX655	GRA26798/EA	655
LTX323	GRA26734/EA	323	LTX529	GRA26760/EA	529	LTX661	GRA26799/EA	661
LTX325	GRA26735/EA	325	LTX531	GRA09123/EA	531	LTX671	GRA26803/EA	671
LTX327	GRA26737/EA	327	LTX533	GRA26763/EA	533	LTX721	GRA08667/EA	721
LTX329	GRA26738/EA	329	LTX535	GRA09124/EA	535	LTX723	GRA26807/EA	723
LTX331	GRA26740/EA	331	LTX537	GRA26765/EA	537	LTX735	GRA26809/EA	735
LTX335	GRA26742/EA	335	LTX541	GRA26769/EA	541	LTX817	GRA26810/EA	817
LTX409	GRA26743/EA	409	LTX543	GRA26772/EA	543	LTX819	GRA26812/EA	819
LTX411	GRA07096/EA	411	LTX545	GRA26773/EA	545	LTX821	GRA26813/EA	821
LTX413	GRA07100/EA	413	LTX551	GRA26774/EA	551	LTX831	GRA26815/EA	831



RAC X LTX
SwitchTip

TIP INDEX



RAC X FFLP SwitchTip

RAC X Fine Finish Low Pressure SwitchTips								
PART #	PPG SKU	SIZE	PART #	PPG SKU	SIZE	PART #	PPG SKU	SIZE
FFLP108	GRA39433/EA	108	FFLP308	GRA39439/EA	308	FFLP510	GRA39446/EA	510
FFLP110	GRA39452/EA	110	FFLP310	GRA39440/EA	310	FFLP512	GRA39447/EA	512
FFLP112	GRA39435/EA	112	FFLP312	GRA39441/EA	312	FFLP514	GRA39448/EA	514
FFLP208	GRA39436/EA	208	FFLP314	GRA39442/EA	314	FFLP516	GRA39449/EA	516
FFLP210	GRA39437/EA	210	FFLP410	GRA39443/EA	410	FFLP616	GRA39451/EA	616
FFLP212	GRA39438/EA	212	FFLP412	GRA39444/EA	412			
FFLP214	GRA40414/EA	214	FFLP414	GRA39445/EA	414			



RAC X LP SwitchTip

RAC X Low Pressure SwitchTips								
PART #	PPG SKU	SIZE	PART #	PPG SKU	SIZE	PART #	PPG SKU	SIZE
LP313	GRAX9487/EA	313	LP619	GRAX9492/EA	619	LP525	GRAX9499/EA	525
LP315	GRAX9514/EA	315	LP421	GRAX9497/EA	421	LP625	GRAX9504/EA	625
LP415	GRAX9489/EA	415	LP521	GRAX9497/EA	521	LP725	GRAX9511/EA	725
LP515	GRAX9507/EA	515	LP621	GRAX9502/EA	621	LP527	GRAX9500/EA	527
LP417	GRAX9490/EA	417	LP423	GRAX9493/EA	423	LP627	GRAX9505/EA	627
LP517	GRAX9495/EA	517	LP523	GRAX9498/EA	523	LP629	GRAX9506/EA	629
LP617	GRAX9508/EA	617	LP623	GRAX9503/EA	623	LP729	GRAX9513/EA	729
LP419	GRAX9491/EA	419	LP723	GRAX9510/EA	723	LP631	GRAX9509/EA	631
LP519	GRAX9496/EA	519	LP425	GRAX9494/EA	425	LP731	GRAX9488/EA	731

*Specialty tips such as Line Striping, Wide RAC, Industrial and Flat tips also available



RAC X Tip Guard

246215	GRA88165/EA	7/8" Thread HandTite™ RAC X Tip Guard (Blue) - For LTX, WideRac™, LP, FFLP SwitchTips
246437	GRA91302/EA	11/16" Thread HandTite™ RAC X Tip Guard (Blue) - For ASM®/Wagner
243161	GRA91294/EA	7/8" Thread HandTite™ RAC 5 Tip Guard (Orange)
243263	GRA91950/EA	11/16" Thread HandTite™ RAC 5 Tip Guard (Orange) - ASM/Wagner
243281	GRA92093/EA	RAC 5 OneSeal™ Gasket & Seal 5 Pack
246453	GRA91196/EA	RAC X LTX & WR OneSeal Gasket & Seal 5 Pack
17P501	GRA41194/EA	RAC X LP & FFLP OneSeal Gasket & Seal - 5 Pack
220251	GRA25507/EA	Flat Tip Guard - 7/8" thread
XHD001	GRA26391/EA	7/8" Thread Xtreme Heavy Duty Guard (Gray)



RAC 5 Tip Guard



Xtreme Heavy Duty Guard

TITAN TIP INDEX

SC-6+ Tips								
PART #	PPG SKU	SIZE	PART #	PPG SKU	SIZE	PART #	PPG SKU	SIZE
662-107	TTI20830/EA	107	662-335	TTI21179/EA	335	662-539	TTI21199/EA	539
662-109	TTI20831/EA	109	662-407	TTI21180/EA	407	662-543	TTI21200/EA	543
662-111	TTI20832/EA	111	662-409	WST21181/EA	409	662-545	TTI21201/EA	545
662-113	TTI20833/EA	113	662-411	WST20851/EA	411	662-551	TTI21202/EA	551
662-115	WST21165/EA	115	662-413	WST20852/EA	413	662-555	TTI21203/EA	555
662-117	TTI21166/EA	117	662-415	WST20853/EA	415	662-609	TTI21206/EA	609
662-207	TTI20834/EA	207	662-417	WST20854/EA	417	662-611	TTI21207/EA	611
662-209	WST20835/EA	209	662-419	WST20855/EA	419	662-613	TTI21208/EA	613
662-211	WST20836/EA	211	662-421	WST20856/EA	421	662-615	WST20866/EA	615
662-213	WST20837/EA	213	662-423	TTI20857/EA	423	662-617	WST20867/EA	617
662-215	WST20838/EA	215	662-425	TTI21182/EA	425	662-619	WST20868/EA	619
662-217	WST20839/EA	217	662-427	TTI21183/EA	427	662-621	WST20869/EA	621
662-219	TTI21167/EA	219	662-429	TTI21184/EA	429	662-623	WST21209/EA	623
662-221	TTI21168/EA	221	662-431	TTI21185/EA	431	662-625	TTI20870/EA	625
662-223	TTI20840/EA	223	662-433	TTI21186/EA	433	662-627	TTI20871/EA	627
662-225	WST21169/EA	225	662-435	TTI21187/EA	435	662-629	TTI21210/EA	629
662-227	TTI21170/EA	227	662-439	TTI21188/EA	439	662-631	WST20872/EA	631
662-229	TTI21171/EA	229	662-443	TTI21189/EA	443	662-633	WST21211/EA	633
662-231	TTI21172/EA	231	662-445	TTI21190/EA	445	662-635	WST21212/EA	635
662-233	TTI21173/EA	233	662-451	TTI21191/EA	451	662-639	TTI21213/EA	639
662-235	TTI21174/EA	235	662-455	TTI21192/EA	455	662-643	TTI21214/EA	643
662-307	TTI20841/EA	307	662-509	TTI21193/EA	509	662-645	TTI21215/EA	645
662-309	WST20842/EA	309	662-511	WST20858/EA	511	662-651	TTI21216/EA	651
662-311	WST20843/EA	311	662-513	WST20859/EA	513	662-655	TTI21217/EA	655
662-313	WST20844/EA	313	662-515	WST20860/EA	515	662-719	TTI21220/EA	719
662-315	WST20845/EA	315	662-517	WST20861/EA	517	662-721	TTI21221/EA	721
662-317	WST20846/EA	317	662-519	WST20862/EA	519	662-731	TTI21222/EA	731
662-319	WST20847/EA	319	662-521	WST20863/EA	521	662-735	TTI21223/EA	735
662-321	TTI20848/EA	321	662-523	WST21194/EA	523	662-821	TTI21224/EA	821
662-323	WST21175/EA	323	662-525	WST20864/EA	525	662-831	TTI21225/EA	831
662-325	TTI20849/EA	325	662-527	WST21195/EA	527	662-417T	TTI22084/EA	417
662-327	TTI21176/EA	327	662-529	WST21196/EA	529	662-419T	TTI22481/EA	419
662-329	TTI21177/EA	329	662-531	WST20865/EA	531	662-515T	TTI27584/EA	515
662-331	WST20850/EA	331	662-533	TTI21197/EA	533			
662-333	TTI21178/EA	333	662-535	WST21198/EA	535			



SC-6+ Tip

TITAN TIP INDEX



TR-1 Tip

TR-1 Tips					
PART #	PPG SKU	SIZE	PART #	PPG SKU	SIZE
695-209	WST20916/EA	209	695-413	WST20925/EA	413
695-211	WST20918/EA	211	695-415	WST20929/EA	415
695-213	WST20923/EA	213	695-417	WST20934/EA	417
695-215	WST20927/EA	215	695-513	WST20926/EA	513
695-217	WST20932/EA	217	695-515	WST20930/EA	515
695-311	WST20919/EA	311	695-517	WST20935/EA	517
695-313	WST20924/EA	313	695-519	WST20939/EA	519
695-315	WST20928/EA	315	695-521	WST20943/EA	521
695-317	WST20933/EA	317	695-525	WST20948/EA	525
695-411	WST20920/EA	411	695-627	WST20950/EA	627



Fine Finish Tip

Fine Finish Tips					
PART #	PPG SKU	SIZE	PART #	PPG SKU	SIZE
671-208	TTI39521/EA	208	671-408	TTI39490/EA	408
671-210	TTI39524/EA	210	671-410	TTI39484/EA	410
671-212	TTI39460/EA	212	671-412	TTI39556/EA	412
671-214	TTI39547/EA	214	671-414	TTI39503/EA	414
671-308	TTI39504/EA	308	671-510	TTI39534/EA	510
671-310	TTI39456/EA	310	671-512	TTI39557/EA	512
671-312	TTI39463/EA	312	671-514	TTI39500/EA	514
671-314	TTI39502/EA	314	671-612	TTI39487/EA	612



High Efficiency Airless Tip

High Efficiency Airless Tip					
PART #	PPG SKU	SIZE	PART #	PPG SKU	SIZE
330-211	TTI27031/EA	211	330-515	TTI27038/EA	515
330-213	TTI27034/EA	213	330-517	TTI27041/EA	517
330-311	TTI27032/EA	311	330-519	TTI27043/EA	519
330-313	TTI27035/EA	313	330-521	TTI27085/EA	521
330-411	TTI27033/EA	411	330-615	TTI27039/EA	615
330-413	TTI27036/EA	413	330-617	TTI27042/EA	617
330-415	TTI27037/EA	415	330-619	TTI27044/EA	619
330-417	TTI27040/EA	417	330-621	TTI27089/EA	621
330-421	TTI27245/EA	421			



TITAN TIP GUARD

289228	WST20878/EA	SC-6+, TR 1, TR-2 Tip Guard
661-027	TTI40003/EA	TR1 High Pressure Tip Guard



THE MI-T-M DIFFERENCE IS ONE IN A MILLION...

One million square feet to be exact! The Mi-T-M manufacturing facility located in Peosta, Iowa spans one-million square feet and is where 450 dedicated employees build and assemble the industrial equipment known for its rugged durability. Mi-T-M's outstanding quality assurance, means you can count on your equipment to be ready for whatever challenge you throw at it.

Customer satisfaction is a top priority at Mi-T-M. A dedicated Sales and Sales Support team is available to talk with you whenever the need arises.















Fabrication Department ■ **Parts Shipped Daily** ■ **Assembly Department**

Mi-T-M Manufactures: Cold & Hot Water Pressure Washers | Air Compressors | Portable Generators
Air Compressor/Generator Combinations | Air Compressor/Generator/Welder Combinations | Wet/Dry Vacuums
Jobsite Boxes | Portable Heaters | Water Pumps | Water Treatment Systems

PRESSURE WASHERS COLD WATER

COLD WATER - LIGHT & MEDIUM USAGE

Usage Per Week	2 - 5 Hours		10 - 15 Hours	
	 		 	
	 		 	
Product Official Name	ChoreMaster			
Gas	Gas	Gas	Gas	Gas
Vendor #	CM-2700-OMLB	CM-3200-OMMB	CM-4200-OMMB	CMB-4004-OMLB
PPG #	MTM03064/EA	MTM17558/EA	MTM17588/EA	MTM01178/EA
PSI	2700	3200	4200	4000
Gallons Per Minute	2.4	2.4	3.4	3.4
Direct or Belt Drive	Direct	Direct	Direct	Belt
Engine	Mi-T-M 212cc OHV	Mi-T-M 212cc OHV	Mi-T-M 420cc OHV	Mi-T-M 420cc OHV
Pump	Mi-T-M Axial, Fixed Pressure	Mi-T-M Crankshaft, Adj. Pressure	AR Crankshaft, Adj. Pressure	AR Crankshaft, Adj. Pressure
Warranties	1 Year Pump & Engine, 30 Days Gun/Unloader Valve/Hose	1 Year Pump & Engine, 30 Days Gun/Unloader Valve/Hose	1 Year Pump & Engine, 30 Days Gun/Unloader Valve/Hose	1 Year Pump & Engine, 30 Days Gun/Unloader Valve/Hose
Includes	25' Hose, 36" Spray Wand, 3 Quick Connect Nozzles, 10" Tires - Portable, Built in Detergent Injector	25' Hose, 36" Spray Wand, 3 Quick Connect Nozzles, 10" Tires - Portable, Built in Detergent Injector	50' Hose, 36" Spray Wand, 3 Quick Connect Nozzles, 10" Tires - Portable, Built in Detergent Injector	50' Hose, 36" Spray Wand, 3 Quick Connect Nozzles, 10" Tires - Portable, Built in Detergent Injector
Selling Features	Light usage pressure washer for basic exterior cleaning.	Use to keep siding and equipment clean.	Use to keep siding and equipment clean.	Use to keep siding and equipment clean.

Usage Per Week	15 - 20 Hours	
COLD WATER - MEDIUM USAGE	 	 
	Product Official Name	
	Gas	Gas
Vendor #	WP-3200-0MHB	WP-4200-0MHB
PPG #	MTM17504/EA	MTM17584/EA
PSI	3200	4200
Gallons Per Minute	2.4	3.4
Direct or Belt Drive	Direct	Direct
Engine	Honda GX200 OHV	Honda GX390 OHV
Pump	Mi-T-M Crankshaft, Adjustable Pressure	AR Crankshaft, Adjustable Pressure
Warranties	1 Year Pump, 3 Year Honda Engine, 30 Days Gun/ Unloader Valve/Hose	1 Year Pump, 3 Year Honda Engine, 30 Days Gun/ Unloader Valve/Hose
Includes	25' Hose, 36" Spray Wand, 3 Quick Connect Nozzles, 10" Tires - Portable, Built in Detergent Injector	50' Hose, 36" Spray Wand, 3 Quick Connect Nozzles, 10" Tires - Portable, Built in Detergent Injector
Selling Features	Handle tough cleaning jobs for small businesses and property owners.	Handle tough cleaning jobs for small businesses and property owners.

PRESSURE WASHERS COLD WATER

Usage Per Week

COLD WATER - CONTRACTOR USAGE



Product Official Name

Job Pro Aluminum - Direct

Gas

Gas

Vendor #

CA-2703-1MMH

CA-3003-1MAH

PPG #

MTM59146/EA

MTM50013/EA

PSI

2700

3000

Gallons Per Minute

2.4

3.0

Direct or Belt Drive

Direct

Direct

Engine

Honda GX200 OHV

Honda GX270 OHV

Pump

Mi-T-M Crankshaft

AR Crankshaft

Warranties

1 Year Mi-T-M Unloader, 2 Year Parts/Labor, 3 Year Honda Engine, 90 Days Gun/Wand/Hose, 7 Year Pump (lifetime manifold)

1 Year Mi-T-M Unloader, 2 Year Parts/Labor, 3 Year Honda Engine, 90 Days Gun/Wand/Hose, 7 Year Pump (lifetime manifold)

Includes

50' Hose, 36" Spray Wand, 3 Quick Connect Nozzles, 10" Tires - Portable, Isolation Plate - reduce vibration. Lightweight Aluminum Frame

50' Hose, 36" Spray Wand, 3 Quick Connect Nozzles, 10" Tires - Portable, Isolation Plate - reduce vibration. Lightweight Aluminum Frame

Selling Features

Powerful to remove peeling paint, mold and mildew.

Powerful to remove peeling paint, mold and mildew.

20 - 30 Hours

















Job Pro Aluminum - Direct

Gas	Gas	Gas
CA-3504-1MAH	CA-4004-1MAH	CA-4004-1MCH
MTM58705/EA	MTM17547/EA	MTM21292/EA
3500	4000	4000
3.5	3.5	4.0
Direct	Direct	Direct
Honda GX390 OHV	Honda GX390 OHV	Honda GX390 OHV
AR Crankshaft	AR Crankshaft	CAT with External Bypass
1 Year Mi-T-M Unloader, 2 Year Parts/Labor, 3 Year Honda Engine, 90 Days Gun/Wand/Hose, 7 Year Pump (lifetime manifold)	1 Year Mi-T-M Unloader, 2 Year Parts/Labor, 3 Year Honda Engine, 90 Days Gun/Wand/Hose, 7 Year Pump (lifetime manifold)	1 Year Mi-T-M Unloader, 2 Year Parts/Labor, 3 Year Honda Engine, 90 Days Gun/Wand/Hose, 7 Year Pump (lifetime manifold)
50' Hose, 48" Spray Wand, 3 Quick Connect Nozzles, 13" Tires - Portable, Isolation Plate - reduce vibration. Lightweight Aluminum Frame	50' Hose, 48" Spray Wand, 3 Quick Connect Nozzles, 13" Tires - Portable, Isolation Plate - reduce vibration. Lightweight Aluminum Frame	50' Hose, 48" Spray Wand, 3 Quick Connect Nozzles, 13" Tires - Portable. Lightweight Aluminum Frame
Powerful to remove peeling paint, mold and mildew.	Powerful to remove peeling paint, mold and mildew.	Powerful to remove peeling paint, mold and mildew.

PRESSURE WASHERS COLD WATER

COLD WATER - CONTRACTOR USAGE

Usage Per Week	30 - 40 Hours			
				
				
Product Official Name	Job Pro Aluminum - Belt			
Vendor #	CBA-3504-1MAH	CBA-4004-1MGH	CBA-4004-1MAH	CBA-4004-1MCH
PPG #	MTM61149/EA	MTM37185/EA	MTM17548/EA	MTM21294/EA
PSI	3500	4000	4000	4000
Gallons Per Minute	3.7	4.0	3.4	3.7
Direct or Belt Drive	Belt	Belt	Belt	Belt
Engine	Honda GX390 OHV	Honda GX390 OHV	Honda GX390 OHV	Honda GX390 OHV
Pump	AR Crankshaft	General Crankshaft with External Bypass	AR Crankshaft	CAT with External Bypass
Warranties	1 Year Mi-T-M Unloader, 2 Year Parts/Labor, 3 Year Honda Engine, 90 Days Gun/Wand/Hose, 7 Year Pump (lifetime manifold)	1 Year Mi-T-M Unloader, 2 Year Parts/Labor, 3 Year Honda Engine, 90 Days Gun/Wand/Hose, 7 Year Pump (lifetime manifold)	1 Year Mi-T-M Unloader, 2 Year Parts/Labor, 3 Year Honda Engine, 90 Days Gun/Wand/Hose, 7 Year Pump (lifetime manifold)	1 Year Mi-T-M Unloader, 2 Year Parts/Labor, 3 Year Honda Engine, 90 Days Gun/Wand/Hose, 7 Year Pump (lifetime manifold)
Includes	50' Hose, 48" Spray Wand, 4 Quick Connect Nozzles, 13" Tires - Portable, Isolation Plate - reduce vibration. Lightweight Aluminum Frame	50' Hose, 48" Spray Wand, 4 Quick Connect Nozzles, 13" Tires - Portable, Isolation Plate - reduce vibration. Lightweight Aluminum Frame	50' Hose, 48" Spray Wand, 4 Quick Connect Nozzles, 13" Tires - Portable. Lightweight Aluminum Frame	50' Hose, 48" Spray Wand, 4 Quick Connect Nozzles, 13" Tires - Portable, Isolation Plate - reduce vibration. Lightweight Aluminum Frame
Selling Features	Built for industrial cleaning and removes tough stains on concrete.	Built for industrial cleaning and removes tough stains on concrete.	Built for industrial cleaning and removes tough stains on concrete.	Built for industrial cleaning and removes tough stains on concrete.

Usage Per Week	40 + Hours			
COLD WATER - INDUSTRIAL USAGE	 	 	 	
	Product Official Name			
	CWC Premium Series			
		Gas	Gas	Gas
Vendor #	CWC-5004-4MAH	CWC-6004-4MGH	CWC-7004-4MGH	
PPG #	MTM16830/EA	MTM16833/EA	MTM17841/EA	
PSI	5000	6000	7000	
Gallons Per Minute	4.0	3.7	3.8	
Direct or Belt Drive	Belt	Belt	Belt	
Engine	Honda GX630 OHV w/Electric Start	Honda GX630 OHV w/Electric Start	Honda GX690 OHV w/Electric Start	
Pump	AR Crankshaft with External Bypass	General Crankshaft with External Bypass	General Crankshaft with External Bypass	
Warranties	3 Year Honda Engine, 7 Year AR Pump, 2 Year Parts/Labor and 90 Days Gun/Wand/Hose	3 Year Honda Engine, 7 Year General Pump, 2 Year Parts/Labor and 90 Days Gun/Wand/Hose	3 Year Honda Engine, 7 Year General Pump, 2 Year Parts/Labor and 90 Days Gun/Wand/Hose	
Includes	50' Hose, 48" Spray Wand, 4 Quick Connect Nozzles, 13" Tires with Locking Brake - Portable	50' Hose, 48" Spray Wand, 4 Quick Connect Nozzles, 13" Tires with Locking Brake - Portable	50' Hose, 48" Spray Wand, 4 Quick Connect Nozzles, 13" Tires with Locking Brake - Portable	
Selling Features	Most durable cold water pressure washer built for heavy-duty cleaning.	Most durable cold water pressure washer built for heavy-duty cleaning.	Most durable cold water pressure washer built for heavy-duty cleaning.	

PRESSURE WASHERS COLD WATER

COLD WATER - INDUSTRIAL USAGE

Usage Per Week

40 + Hours



Product Official Name	CW Premium Series			
	Gas	Gas	Gas	Gas
Vendor #	CW-2505-4MGH	CW-3504-5MGH	CW-4004-5MGH	CW-4004-5MVO
PPG #	MTM00364/EA	MTM67134/EA	MTM67219/EA	MTM67196/EA
PSI	2500	3500	4000	4000
Gallons Per Minute	4.4	3.8	3.5	4.0
Direct or Belt Drive	Belt	Belt	Belt	Belt
Engine	Honda GX390 OHV	Honda GX390 OHV	Honda GX390 OHV	Honda GX390 OHV
Pump	General Crankshaft	General Crankshaft	General Crankshaft	General with External Bypass
Warranties	1 Year Mi-T-M Unloader, 3 Year Honda Engine, 10 Year General Pump, 2 Year Parts/Labor and 90 Days Gun/Wand/Hose	1 Year Mi-T-M Unloader, 3 Year Honda Engine, 10 Year General Pump, 2 Year Parts/Labor and 90 Days Gun/Wand/Hose	1 Year Mi-T-M Unloader, 3 Year Honda Engine, 10 Year General Pump, 2 Year Parts/Labor and 90 Days Gun/Wand/Hose	1 Year Mi-T-M Unloader, 3 Year Engine, 10 Year General Pump, 2 Year Parts/Labor and 90 Days Gun/Wand/Hose
Includes	50' Hose, 48" Spray Wand, 4 Quick Connect Nozzles, 13" Tires - Portable, External Bypass	50' Hose, 48" Spray Wand, 4 Quick Connect Nozzles, 13" Tires - Portable, External Bypass	50' Hose, 48" Spray Wand, 4 Quick Connect Nozzles, 13" Tires - Portable, External Bypass	50' Hose, 48" Spray Wand, 4 Quick Connect Nozzles, 13" Tires - Portable, External Bypass
Selling Features	Workhorse of industrial pressure washers used for extended cleaning applications.	Workhorse of industrial pressure washers used for extended cleaning applications.	Workhorse of industrial pressure washers used for extended cleaning applications.	Workhorse of industrial pressure washers used for extended cleaning applications.

Usage Per Week 20 - 30 Hours

**HOT WATER -
INDUSTRIAL
USAGE**







Product Official Name	HSP Series	
	Gas	Gas
Vendor #	HSP-2503-0MMH	HSP-3003-3MGH
PPG #	MTM00435/EA	MTM01746/EA
PSI	2500	3000
Gallons Per Minute	2.6	2.9
Direct or Belt Drive	Direct	Direct
Engine	Honda GX200 OHV	Honda GX270 OHV
Pump	Mi-T-M Crankshaft	AR Crankshaft with External Bypass
Warranty	3 Year Coil, 3 Year Honda Engine, 7 Year Mi-T-M Pump, 1 Year Parts/Labor	3 Year Coil, 3 Year Honda Engine, 7 Year AR Pump, 1 Year Parts/Labor
Includes	50' Hose, Insulated Dual Spray Wand, 4 Quick Connect Nozzles, 13" Tires - Portable, Electro Magnetic Firing System	50' Hose, Insulated Dual Spray Wand, 4 Quick Connect Nozzles, 13" Tires - Portable, Electro Magnetic Firing System
Selling Features	Great for removing mud and muck from construction equipment.	Great for removing mud and muck from construction equipment.



PRESSURE WASHERS HOT WATER

HOT WATER - INDUSTRIAL USAGE continued

Usage Per Week	20 - 30 Hours		
	 	 	 
Product Official Name	HSP & HS Series		
	Gas	Gas	Gas
Vendor #	HSP-3504-3MGH	HS-3505-1MGH	HS-4004-1MAH
PPG #	MTM00504/EA	MTM99854/EA	MTM99856/EA
PSI	3500	3500	4000
Gallons Per Minute	3.3	4.7	4.0
Direct or Belt Drive	Direct	Belt	Belt
Engine	Honda GX390 OHV	Honda GX630 OHV	Honda GX630 OHV
Pump	AR Crankshaft with External Bypass	General	AR
Warranties	3 Year Coil, 3 Year Honda Engine, 7 Year AR Pump, 1 Year Parts/Labor	3 Year Coil, 3 Year Honda Engine, 7 Year General Pump, 1 Year Parts/Labor	3 Year Coil, 3 Year Honda Engine, 7 Year AR Pump, 1 Year Parts/Labor
Includes	50' Hose, Insulated Dual Spray Wand, 4 Quick Connect Nozzles, 13" Tires - Portable, Electro Magnetic Firing System, External Bypass	50' Hose, Insulated Dual Spray Wand, 4 Quick Connect Nozzles, Skid Mount, External Bypass System	50' Hose, Insulated Dual Spray Wand, 4 Quick Connect Nozzles, Skid Mount, External Bypass System
Selling Features	Great for removing mud and muck from construction equipment.	Rugged skid frame makes it a great option for mounting on water trailer. Clean dirt, oil, grime anywhere. Stands up to harsh elements of industrial pressure washing.	Rugged skid frame makes it a great option for mounting on water trailer. Clean dirt, oil, grime anywhere. Stands up to harsh elements of industrial pressure washing.

Usage Per Week	30 - 40 Hours	Varies		
<h2>HOT WATER - PRESSURE WASHER TRAILERS</h2>	 	 	 	
	Product Official Name	Hot Water		
		Hot Water Mini Trailer	Single-Axle Trailer	Dual-Axle Trailer
	Vendor #	HMT-4004-OMGH	AW-9000-0005*	AW-9000-0003*
PPG #	MTM21323/EA	MTM00110/EA	MTM99600/EA	
PSI	4000	Your Choice of Pressure Washer	Your Choice of Pressure Washer	
Gallons Per Minute	3.7			
Direct or Belt Drive	Belt			
Engine	Honda GX390 OHV			
Pump	General Crankshaft			
Warranties	3 Year Honda Engine, 7 Year General Pump			
Additional Features	Dual Spray Wand, 4 Quick Connect Nozzles, 50' Hose. DOT Approved and NATM Certified, 15" Tires & 3500lb Axle	200 Gallon Water Tank, 2" Ball Hitch Hooks, 15" Tires & 3500lb Axle	Two - 200 Gallon Water Tanks, 2" Ball Hitch Hooks, 15" Tires & (2) 3500lb Axles	
Comments	Does not include water tank. Recommended maximum speed is 65 mph.	Trailer only, Customizable/built to order (Pressure Washer, Hose Reel, Hoses, Water Tanks, etc.)	Trailer only, Customizable/built to order (Pressure Washer, Hose Reel, Hoses, Water Tanks, etc.)	

*Other Trailer Choices

*Other Trailer Choices

ROTARY SURFACE CLEANERS



	14" Diameter Attachment	20" Diameter	20" Diameter w/Casters	24" Diameter	28" Diameter
Vendor #	AW-7020-8009	AW-7020-8003	AW-7020-8010	AW-7020-8006	AW-7020-8001
PPG #	MTM17793/EA	MTM01184/EA	MTM19629/EA	MTM16964/EA	MTM98001/EA
PSI	4200	4000	4000	4000	4000
Gallons Per Minute	8.0	3.0 - 5.0	3.0 - 5.0	4.0	4.0 - 10.0
Max Temperature	180 Degrees Fahrenheit	180 Degrees Fahrenheit	180 Degrees Fahrenheit	180 Degrees Fahrenheit	212 Degrees Fahrenheit
Selling Features	Cleans large surfaces faster & easier than standard nozzle. For horizontal surfaces. Attaches to pressure washer wand.	Cleans large surfaces faster & easier than standard nozzle. For horizontal surfaces	Cleans large surfaces faster & easier than standard nozzle. For horizontal surfaces	Cleans large surfaces faster & easier than standard nozzle. For horizontal surfaces	Cleans large surfaces faster & easier than standard nozzle. For horizontal surfaces

HOSE, GUN/WANDS, & EXTENSIONS

	 Mi-T-M 	 Mi-T-M 	 Mi-T-M 	 Mi-T-M 	 Mi-T-M 
	High Pressure Hose	Gun & Wand Assembly	Extended Reach Wands	Aluminum Wand Extensions	Gutter Cleaner
Vendor #	AW-0851-0338	851-0095	AW-7018-1200, AW-7018-1800, AW-7018-2400	AW-7105-3600, AW-7105-4800, AW-7105-7200	50-0201
PPG #	MTM01822/EA	MTM86095/EA	MTM00742/EA, MTM00743/EA, MTM00804/EA	MTM21158/EA, MTM21159/EA, MTM21160/EA	MTM01231/EA
Size	3/8" X 50'	36"	12', 18', 24'	36", 48", 72"	1/4" Quick Connect Outlet/Inlet
Attributes	Includes Quick Connects, Swivel & Bend Restrictors	4000 PSI Rated, includes Quick Connects	Safety Lock, Trigger Gun, Quick Connects	Quick Connect Plug, 12.0 GPM Flow Rate	Attach to Extensions
Selling Features	Provides extra mobility & length.	Professional grade trigger gun w/safety lock	Clean higher hard to reach areas	Clean hard to reach areas with ease	Cleans gutters from the ground

PRESSURE WASHER ACCESSORIES

NOZZLES

					
					
	Rotating Nozzles	Rotating Nozzles	Multi-Function Nozzles	Long Range Chemical Nozzle	Nozzles 4 Packs
Vendor #	AW-7500-0035, AW-7500-0004	AW-7510-0035, AW-7510-0004	AW-7200-0035, AW-7200-0004	18-0373	AW-4035-0000, AW-4004-0000
PPG #	MTM75035/EA, MTM75004/EA	MTM17757/EA, MTM21193/EA	MTM17478/EA, MTM17762/EA	MTM01709/EA	MTM36033/EA, MTM36000/EA
Size	3.5 Orifice, 4.0 Orifice	3.5 Orifice, 4.0 Orifice	3.5 Orifice, 4.0 Orifice	N.A.	3.5 Orifice. 4.0 Orifice
Attributes	0 Degree Spray Impact w/25 Degree Coverage	0 Degree Spray Impact w/25 Degree Coverage	6 nozzles - 0, 15, 25, & 40 Degrees, Wash & Rinse	Low Pressure, Quick connects to end of wand	4 nozzles - 0, 15, 25, & 40 Degrees
PSI Rating	6000 PSI Rated	5100 PSI Rated	4200 PSI Rated	N.A.	N.A.
Selling Features	Increase cleaning power & decrease cleaning time	Increase cleaning power & decrease cleaning time	6 nozzles in one, offer longer life & durability	Has range of 30' while drawing chemical for effective cleaning	Variety of quick connect nozzles, fits most units

INVERTER GENERATORS



	2000 Watt	3000 Watt
Vendor #	GEN-2000-IMMO	GEN-3000-IMMO
PPG #	MTM17696/EA	MTM17881/EA
Max AC Output	2000 Watts	3000 Watts
Displacement/Engine	79cc Mi-T-M OHV	212cc Mi-T-M OHV
Run Time (@ Half Load)	6.0 Hours	6.8 Hours
Receptacles	(1) 120V, 20A Duplex (1) 12V DC, 8.0A	(1) 120V, 20A Duplex (1) 12V DC, 30A Twist Lock (1) 12V DC, 8.3A
Decibel Rating	63.0	68.0
Weight	48 LB	84 LB
Warranty	1 Year Alternator, 1 Year Mi-T-M Engine	1 Year Alternator, 1 Year Mi-T-M Engine
Includes	DC/battery charging and USB port for electronics.	DC/battery charging and USB port for electronics.
Selling Features	Commercial quality AC power so you can charge sensitive electronic equipment such as smart phones, computers and tablets.	Commercial quality AC power so you can charge sensitive electronic equipment such as smart phones, computers and tablets.

CHOREMASTER GENERATORS

	 	 	 
	3600 Watts	6000 Watts	8000 Watts
Vendor #	GEN-3600-OMMO	GEN-6000-OMMO	GEN-8000-OMME
PPG #	MTM01721/EA	MTM21154/EA	MTM21155/EA
Max AC Output	3600 Watts	6000 Watts	8000 Watts
Displacement/Engine	212cc Mi-T-M OHV	389cc Mi-T-M OHV	420cc Mi-T-M OHV with electric start
Alternator	Brushed 120V	Brushed 120V/240V	Brushed 120V/240V
Run Time (@ Full Load)	8.5 Hours	6.5 Hours	6.0 Hours
Receptacles	(2) 120V, 20A GFCI Duplex, (1) 120V, 30A Twist Lock, (1) 12V DC 8.3A	(2) 120V, 20A GFCI Duplex, (1) 120V, 30A Twist Lock, (1) 120V/240V, 20A Twist Lock, (1) 12V DC 8.3A	(2) 120V, 20A GFCI Duplex, (1) 120V, 30A Twist Lock, (1) 120V/240V, 20A Twist Lock, (1) 12V DC 8.3A
Fuel Capacity	4.0 Gallons	6.6 Gallons	6.6 Gallons
Decibel Rating	72.0	74.0	74.0
Weight	102 LB	180 LB	195 LB
Warranty	1 Year Alternator, 1 Year Mi-T-M Engine	1 Year Alternator, 1 Year Mi-T-M Engine	1 Year Alternator, 1 Year Mi-T-M Engine
Includes	No Wheel Kit Included; DC/Battery charging	Tires & Rubber Grip Handles; DC/Battery charging	Tires & Rubber Grip Handles; DC/Battery Charging
Selling Features	Maximum power for contractors and electrical back-up during power outages.	Maximum power for contractors and electrical back-up during power outages.	Maximum power for contractors and electrical back-up during power outages.

PORTABLE GENERATORS

				
				
	3000 Watts	5000 Watts	7500 Watts	14,000 Watts
Vendor #	GEN-3000-1MHO	GEN-5000-0MHO	GEN-7500-0MHO	GEN-14000-1MHE
PPG #	MTM20097/EA	MTM17388/EA	MTM01928/EA	MTM99974/EA
Max AC Output	3000 Watts	5000 Watts	7500 Watts	14,000 Watts
Displacement/Engine	163cc Honda GX160 OHV	270cc Honda GX270 OHV	389cc Honda GX390 OHV	688cc Honda GX630 OHV w/ Electric Start, Battery Included
Alternator	Brushless 120V	Brushless 120V/240V	Brushless 120V/240V	Brushless 120V/240V
Run Time (@ Full Load)	7.4 Hours	6.8 Hours	6.9 Hours	8.0 Hours
Receptacles	(1) 120V, 20A GFCI Duplex	(2) 120V, 20A GFCI Duplex, (1) 120V, 30A Twist Lock, (1) 120V/240V, 20A Twist Lock	(2) 120V, 20A GFCI Duplex, (1) 120V, 30A Twist Lock, (1) 120V/240V, 20A Twist Lock	(2) 120V, 20A GFCI Duplex, (1) 120V, 30A Twist Lock, (1) 120V/240V, 20A Twist Lock (1)120V/240V, 50A
Fuel Capacity	2.6 Gallons	5.7 Gallons	7.3 Gallons	13.2 Gallons
Decibel Rating	74.8	73.8	80	77.5
Weight	130 LB	176 LB	233 LB	508 LB
Warranty	2 Year Alternator, 3 Year Honda Engine	2 Year Alternator, 3 Year Honda Engine	2 Year Alternator, 3 Year Honda Engine	2 Year Alternator, 3 Year Honda Engine
Includes	Brushless Alternator	Brushless Alternator	Brushless Alternator	Wheel Kit & Brushless Alternator
Selling Features	Ideal to power multiple tools on jobsites without electricity.	Ideal to power multiple tools on jobsites without electricity.	Ideal to power multiple tools on jobsites without electricity.	Built for industrial applications.

* Also available large towable generators - contact Equipment Category Manager for more information

SINGLE STAGE ELECTRIC

	 	 	 	 
	Single Stage Electric	Single Stage Electric	Single Stage Electric	Single Stage Electric
Vendor #	AM1-HE02-04M	AM1-PE02-05M	AM1-PE15-08M	AM1-PE02-08M
PPG #	MTM17393/EA	MTM17394/EA	MTM99380/EA	MTM99381/EA
Type	Hand Carry, Electric	Portable, Electric	Portable, Electric	Portable, Electric
CFM @ PSI	4.2 @ 90	4.2 @ 90	7.3 @ 90	9.2 @ 90
Horsepower/Motor	2.0 HP, 120V, 15.0 A	2.0 HP, 120V, 15.0 A	1.5 HP, 120V, 13.2A with auto start/stop	2.0 HP, 120V, 18.8 A with auto start/stop
Tank Size	4 Gallon	5 Gallon	8 Gallon	8 Gallon
Weight	60 LB	69 LB	170 LB	183 LB
Warranty	1 Year Compressor Pump, 1 Year Electric Motor	1 Year Compressor Pump, 1 Year Electric Motor	1 Year Electric Motor, 2 Year Pump Exchange	1 Year Electric Motor, 2 Year Pump Exchange
Includes	Regulator and gauges so you can easily check tank and outlet pressure.	Regulator and gauges so you can easily check tank and outlet pressure.	Regulator and gauges so you can easily check tank and outlet pressure.	Regulator and gauges so you can easily check tank and outlet pressure.
Selling Features	Hand carry air compressor perfect for powering nail guns and small air tools.	Portable air compressor perfect for powering nail guns and small air tools.	Great choice for powering air tools on jobsites. Wheelbarrow style - easy to move.	Great choice for powering air tools on jobsites. Wheelbarrow style - easy to move.

SINGLE STAGE GAS



	Single Stage Gas	Single Stage Gas	Single Stage Gas
Vendor #	AM1-HM04-05M	AM1-PH65-08M	AM1-PH65-20M
PPG #	MTM17396/EA	MTM99216/EA	MTM99217/EA
Type	Hand Carry, Gas	Wheelbarrow Style, Gas	Portable, Gas
CFM @ PSI	4.8 @ 90	13.9 @ 90	13.9 @ 90
Displacement/Engine	212cc Mi-T-M OHV	196cc Honda GX200 OHV	196cc Honda GX200 OHV
Tank Size	5 Gallon	8 Gallon	20 Gallon
Weight	77 LB	175 LB	212 LB
Warranty	1 Year Compressor Pump, 1 Year Mi-T-M Engine	2 Year Pump Exchange, 3 Year Honda Engine	2 Year Pump Exchange, 3 Year Honda Engine
Includes	Regulator and gauges so you can easily check tank and outlet pressure.	Regulator and gauges so you can easily check tank and outlet pressure.	10" tires and handle make it extremely portable. ASME Receiver Tank.
Selling Features	Hand carry air compressor perfect for powering sanders and paint sprayers.	Provides essential air power required on construction sites. Wheelbarrow style - easy to move.	Ideal air compressor for large construction sites.

TWO STAGE GAS



	Two Stage Gas	Two Stage Gas
Vendor #	AM2-PH09-08M	AM2-PH09-20M
PPG #	MTM99068/EA	MTM99078/EA
Type	Wheelbarrow Style, Gas	Portable, Gas
CFM @ PSI	17.2 @175	17.2 @ 175
Displacement/Engine	270cc Honda GX270 OHV	270cc Honda GX270 OHV
Tank Size	8 Gallon	20 Gallon
Weight	260 LB	306 LB
Warranty	2 Year Pump Exchange, 3 Year Honda Engine	2 Year Pump Exchange, 3 Year Honda Engine
Includes	Regulator and gauges so you can easily check tank and outlet pressure. Handle & 10" Tires for portability.	Regulator and gauges so you can easily check tank and outlet pressure. ASME Receiver Tank.
Selling Features	Ideal for contractors and remodelers who need to power multiple air tools.	Mount in a service truck for air power wherever you go.

ROTARY SCREW



	Rotary Screw Gas
Vendor #	AR1-PK37-M
PPG #	MTM17837/EA
Type	Rotary Screw, Gas
CFM @ PSI	115 @ 100
Displacement/Engine	999cc Kohler CH1000 OHV
Weight	698 LB
Warranty	3 Year Standard (When RotorLub Oil, Filters & Parts are used at prescribe intervals), 3 Year Kohler Engine
Includes	Banded 4 V-belt drive system, Lifting Hook, Winch Point, 15" Tires, & Roll Cage Frame.
Selling Features	Large volume air compressor to power multiple air tools on construction sites.

KEROSENE FORCED AIR



	75,000 BTU	135,000 BTU	190,000 BTU	215,000, 400,000, 600,000
Vendor #	MH-0075-0M10	MH-0135-0M10	MH-0190-0M10	MH-0215-0M10, MH-0400-0M10, MH-0600-0M10
PPG #	MTM17506/EA	MTM17507/EA	MTM17508/EA	MTM99393/EA , MTM99409/EA , MTM99771/EA
Heater Type	Kerosene Forced Air	Kerosene Forced Air	Kerosene Forced Air	Kerosene Forced Air
Heat Output	75,000 BTU	135,000 BTU	190,000 BTU	215,000, 400,000, 600,000 BTU
Heating Area	1700 Sq. Ft.	3100 Sq. Ft.	4300 Sq. Ft.	5300, 10,000, 15,000 Sq. Ft.
Max Operating Hours	8.9 Hours	10.0 Hours	9.1 Hours	8.0 Hours
Warranty	Limited 1 Year	Limited 1 Year	Limited 1 Year	Limited 1 Year
Includes	Built in thermostat with control dial to set your preferred temperature, Sure Start Ignition makes it easy to start in cold temperatures	Built in thermostat with control dial to set your preferred temperature, Sure Start Ignition makes it easy to start in cold temperatures	Built in thermostat with control dial to set your preferred temperature, Sure Start Ignition makes it easy to start in cold temperatures	Built in thermostat with control dial to set your preferred temperature, Sure Start Ignition makes it easy to start in cold temperatures
Selling Features	Portable and ideal for construction work sites.	Portable and ideal for construction work sites.	Portable and ideal for construction work sites.	Portable and ideal for construction work sites.

PROPANE FORCED AIR

					
					
	40,000 - 60,000 BTU	120,000 - 150,000 BTU	150,000 BTU	150,000 BTU	225,000 - 375,000 BTU
Vendor #	MH-0060-LM10	MH-0150-LM10	MH-0150-LMT0	MH-0150-NM10	MH-0375-LM10
PPG #	MTM17425/EA	MTM99412/EA	MTM99411/EA	MTM99414/EA	MTM99413/EA
Heater Type	Propane Forced Air	Propane Forced Air	Propane Forced Air	Natural Gas Forced Air	Propane Forced Air
Heat Output	40,000 - 60,000 BTU	120,000 - 150,000 BTU	150,000 BTU	150,000 BTU	225,000 - 375,000 BTU
Heating Area	1500 Sq. Ft.	3800 Sq. Ft.	3800 Sq. Ft.	3800 Sq. Ft.	9000 Sq. Ft.
Max Operating Hours	10.5 Hours	18 Hours	18 Hours	N/A	11.5 Hours
Warranty	Limited 1 Year	Limited 1 Year	Limited 1 Year	Limited 1 Year	Limited 1 Year
Includes	One touch ignition & heat control, Auto safety shut-off	One touch ignition & heat control, Auto safety shut-off	One touch ignition & heat control, Auto safety shut-off	One touch ignition & heat control, Auto safety shut-off	One touch ignition & heat control, Auto safety shut-off
Selling Features	Ideal for drying and heating where you need it.	Ideal for drying and heating where you need it.	Ideal for drying and heating where you need it.	Ideal for drying and heating where you need it.	Ideal for drying and heating where you need it.

ADDITIONAL HEATERS



	Propane Tank Top Radiant	18,000 BTU Propane Cabinet Utility	60-80,000 BTU Gas Fired Convection
Vendor #	MH-0015-IM10, MH-0030-IM10	MH-0018-OM10	MH-0080-CM10
PPG #	MTM99656/EA, MTM99657/EA	MTM18486/EA	MTM99415/EA
Heater Type	Attaches to Top of Propane Tank	Propane Radiant	Gas Fired Convection
Heat Output	9000 - 16,000, 9000-32,000 BTU	18,000 BTU	60,000 - 80,000 BTU
Heating Area	N/A for this model	600 Sq. Ft.	1800 Sq. Ft.
Max Operating Hours	27 - 48, 14-48 Hours	65 Hours on 20 lb. LP tank (not included)	5 - 43 Hours, dependent on LP tank size
Warranty	Limited 1 Year	Limited 1 Year	Limited 1 Year
Includes	Variable heat control valve, High efficiency heat reflector	Casters	Variable heat control allows you to set your preferred temperature; 360 Degree heat radius
Selling Features	Radiant heat output provides instant, clean and quiet heating.	Radiant heat output - instant, clean heating. No electricity required.	Portable design makes it easy to set up.

ADDITIONAL HEATERS

continued

	 	 	 
	50-200,000 BTU Gas Fired Convection	125,000 BTU Kerosene Radiant	Propane Radiant Outdoor Patio
Vendor #	MH-0200-CM10	MH-0125-3M1R	MH-0042-PM10
PPG #	MTM99416/EA	MTM18095/EA	MTM19510/EA
Heater Type	Gas Fired Convection	Kerosene Radiant	Propane Radiant
Heat Output	50,000 - 200,000 BTU	125,000 BTU	22,500 - 50,000 BTU
Heating Area	4600 Sq. Ft.	3125 Sq. Ft.	290 Sq. Ft.
Max Operating Hours	11 - 31 Hours on 100 lb. LP tank	20.0 Hours	8.5 Hours
Warranty	Limited 1 Year	Limited 1 Year	Limited 1 Year
Includes	Variable heat control allows you to set your preferred temperature; 360 Degree heat radius	Adjust heat height to direct heat where needed, tires	Variable heat control, Wind resistant burner system
Selling Features	Portable design makes it easy to set up.	Compact design and tires make it extremely portable.	Attractive and portable patio and deck heater.

OTHER EQUIPMENT *Select vendors featured - Many other vendor choices*

VENDOR	PHONE	WEBSITE	GENERAL INFORMATION
Featured Vendors			
Graco	800-690-2894	http://www.graco.com/us/en.html	Spray Equipment, Pressure Washers, Pavement Solutions
Titan	800-526-5362	https://www.titantool.com/	Spray Equipment
Mi-T-M	800-553-9053	https://www.mitm.com/	Pressure Washers, Generators, Compressors, Heaters
Blasting Equipment			
Cesco Inc.	888-772-3726	https://www.blastandpaint.com/	Clemco & Schmidt Blasting Equipment
Clear Blast	888-327-7698	https://clearblast.com/	Wet Abrasive Blasting Equipment
Cold Jet	888-675-9915	https://www.coldjet.com/	Dry Ice Blasting Equipment
Blast Media			
10X Engineered Materials	260-209-1207	https://10xem.com/	Superalloy Abrasives
GMA Garnet	832-243-9300	https://www.gmagarnet.com/en-us/	Garnet
Harsco Minerals	888-733-3646	https://www.harsco-environmental.com/	Coal & Copper Slag
Metaltec Steel Abrasives	734-459-7900	https://www.metaltecsteel.com/	Steel Grit & Shot
Mil-Spec Abrasives	757-927-6699	https://www.milspecabrasives.us/	Crushed Glass
Mineral Tech	281-462-4220	http://www.mineraltechllc.com/	Coal & Copper Slag
Opta Minerals*	905-689-7361	https://optagroupllc.com/opta-minerals/	Various Blast Media - *Canada Only
Strategic Materials	215-551-3070	https://www.strategicmaterials.com/	Crushed Glass
US Minerals	281-733-0500	https://www.us-minerals.com/	Various Blast Media
Blowers/Fans			
Allegro Industries	800-622-3530	https://www.allegrosafety.com/	Blowers, Fans, & Related Ductwork
Concrete Equipment			
Imer USA	301-336-3700	https://www.imerusa.com/	Mixers & Pumps - Concrete, Mortar, Stucco, & Grout
Filters			
Air Flow Technology (Chemco)	800-323-0431	https://www.filtrationgroup.com/	Spray Booth Filters & Coating
Floor Prep Equipment			
AramSCO	800-767-6933	https://www.aramsco.com/	Various Types & Brands
Edco Inc.	800-638-3326	https://www.edcoinc.com/	Grinders & Dust Collectors
National Flooring Equipment	763-315-5300	https://nationalequipmentdirect.com/#/	Various Types
Niagara Machine	704-329-5701	https://www.niagamachine.com/#/	Various Types & Brands
OnFloor Technologies	877-356-6703	https://onfloor.com/	Grinders & Dust Collectors
Substrate Technology	815-941-4800	https://substratetechnology.com/	Various Types & Brands
Werkmaster	866-373-8375	https://www.werkmaster.com/	Grinders, Hardwood Sanders, Dust Collectors
Heaters			
Heat Wagon	888-432-8924	https://www.heatwagon.com/	Portable & Construction Heaters
Large Towable Equipment			
Doosan Portable Power	704-650-0340	https://www.doosanportablepower.com/	Air Compressors, Generators, Light Towers
SullAir	219-229-3133	https://americas.sullair.com/en	Air Compressors

OTHER EQUIPMENT

Lifts			
Bestline Equipment	814-280-0386	https://www.bestline.com/	JLG Boom & Scissor Lifts
Paint Testing Equipment			
Defelsko	800-448-3835	https://www.defelsko.com/	Coating Thickness & Inspection Instruments
KTA Tator	800-582-4243	https://ktagage.com/	Various Inspection Instruments
Paul N. Gardner Co.	954-946-9454	https://gardco.com/	Various Inspection Instruments
Paint Shakers & Tinting Machines			
Fluid Management	800-462-2466	https://www.fluidman.com/	Tinting Equipment & Paint Shakers
Hero	800-494-4376	https://hero.ca/	Tinting Equipment & Paint Shakers
Pacer Industrial Mixers	888-236-1143	https://www.miraclepaint.com/	Paint Shakers
Radia Products	800-221-1083	https://www.radiaproducts.com/	Paint Shakers
Pressure Washers			
Hotsy	720-376-3420	https://www.hotsy.com/en/	Industrial Pressure Washers
Pressure Pro	772-461-4486	https://www.pressure-pro.com/	Pressure Washers & Trailers
Pressure Works	804-358-1129	https://pressureworksinc.com/	Pressure Washers & Trailers
Simpson/FNA Group	224-689-7053	https://simpsoncleaning.com/	Pressure Washers & Trailers
Sanding Equipment			
Mirka	800-843-3904	https://www.mirka.com/en-US/	Various Power Hand Sanders, Drywall Sander, & Abrasives
Solvent Recycling & Paint Wash Equipment			
Becca Inc.	800-655-5649	https://www.beccainc.com/	Solvent Recycling Equipment
Trimaco	833-274-7747	https://trimaco.com/	Environwash Paint Wash/Treatment Systems
Spray Booths			
Cesco Inc.	888-772-3726	https://www.blastandpaint.com/	Col-met & Global Finishing Spray Booths
Spray Equipment - Industrial			
American Spray Technologies (Cenric)	877-833-4342	https://www.sprayrig.com/	Texture Spray Machines & Large Rigs
Carlisle Fluid Technologies	800-992-4657	https://www.carlisleft.com/	Binks & DeVilbiss Equipment
Dan Am Co.	800-533-8016	https://www.sata.com/en-amn/	Sata Spray Guns
Fuji Spray	800-650-0930	https://www.fujispray.com/	Fuji Spray Equipment & Guns
Hy-Flex Corporation	765-524-6493	https://www.hyflexcorp.com/	Pumps, Mixers, & Sprayers - Plaster, Stucco, Fireproofing
Parker Ionics	734-326-7630	https://www.parkerionics.com/	Powder Coating Equipment
Spray Foam Systems	877-737-4362	https://www.sprayfoamsys.com/systems/	Graco Industrial Spray Equipment & Customized Rigs
WIWA	855-747-0141	https://www.wiwausa.com/	Industrial Spray Equipment
Surface Prep Tools			
Desco Manufacturing	800-337-2648	http://descomfg.com/	Handheld Scarifiers & Grinders, Needle Guns, & Specialty Tools
Tape Masking/Marking Machine			
Precision Floor Marking	816-763-1009	https://www.precisionfloormarking.com/	Floor Taping Machines
Vacuums			
Dustless Tools	800-568-3949	https://www.dustlesstools.com/	Wet/Dry & HEPA Vacuums, Related Dust Shrouds
Wallpaper Pasting Machines			
Advance Equipment	773-287-8220	https://advance-equipment.com/	Wallpaper Pasting Equipment



ABOUT PPG

Founded in 1883 as Pittsburgh Plate Glass by Captain John B. Ford and John Pitcairn in Pittsburgh, Pennsylvania. Today, PPG is a global supplier of paints, coatings, optical products, and specialty materials.

Through leadership in innovation, sustainability and color, PPG helps customers in industrial, transportation, consumer products, and construction markets and aftermarkets to enhance more surfaces in more ways than does any other company.

ppgpaints.com

400 Bertha Lamme Drive | Cranberry Township, PA 16066 | Technical Service: 1-800-441-9695 | ppgpaints.com

©2021 PPG Industries, Inc. All Rights Reserved. The PPG Logo is a registered trademark of PPG Industries Ohio, Inc. Edition: August 2021

